

SPECIFICATION

Product : Topview 3528 White SMD LED

Part No. : IWS-L3514-BW-K3

Date : 2010. 04. 19 Ver. 2.0

| Proposed By | Checked By | Checked By | Checked By | Approval |
|-------------|------------|------------|------------|----------|
| | | | | |

Comment



ITSWELL Co., Ltd
58B-4L, 626-3 Gojan-dong, Namdong-gu, Incheon 405-817 KOREA
TEL:+82-32-813-1801, FAX:+82+32-816-1900
URL: <http://www.itswell.com>,

Topview 3528 SMD LED

IWS-L3514-BW-K3

1. Features

- 3 Chip High-Luminosity SMD LED
- 3.5 x 2.8 x 1.9 mm (L x W x H), Small Size Surface Mount Type
- Wide Viewing Angle
- Long Operating Life

2. Applications

- Automotive: Backlight in Dashboard and Switch
- Lighting Device: Indicator, General Lighting
- Camera Flash, Hand Carrier Flash
- General Use

3. Outline Drawing and Dimension

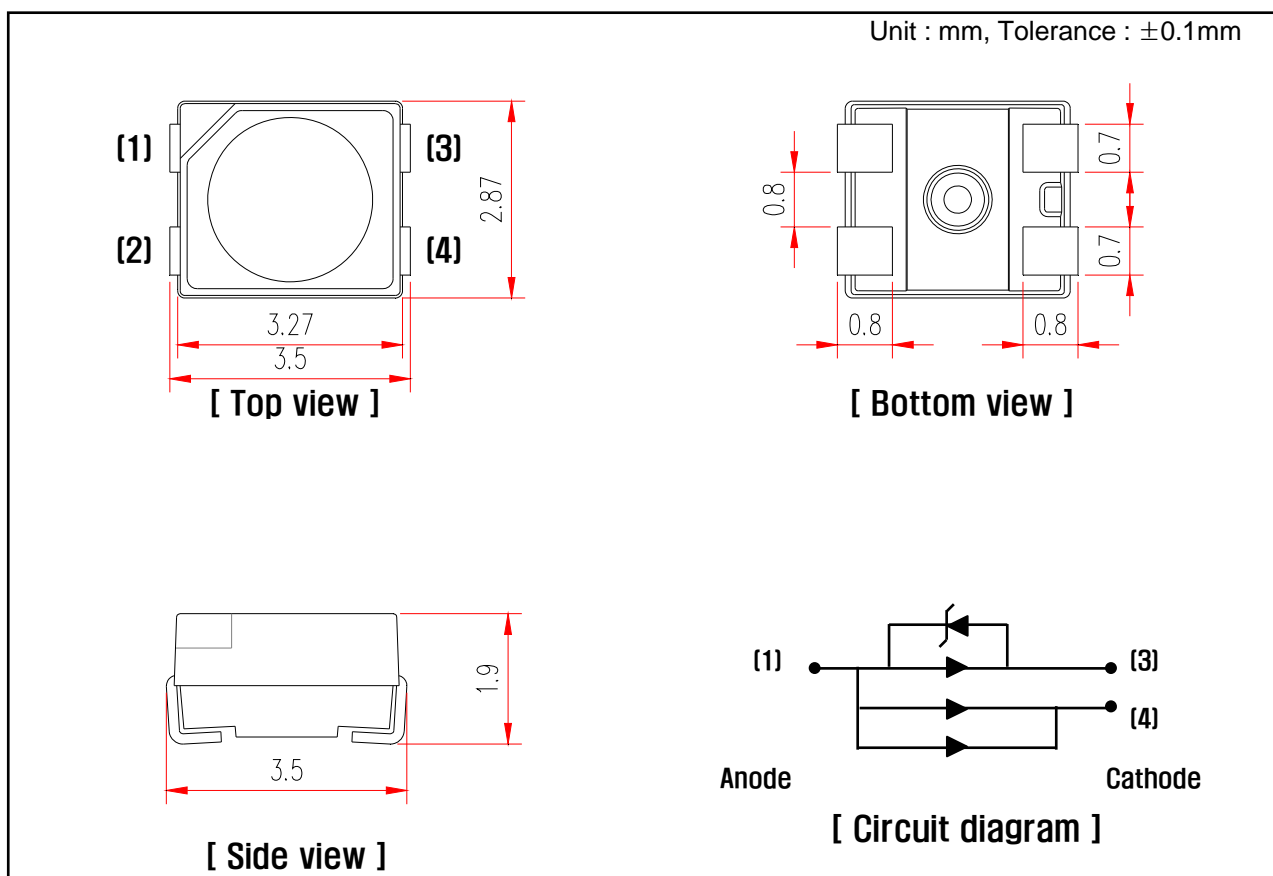

Note

1. All dimensions are in millimeters
2. All dimensions without tolerances are for reference only

4. Absolute Maximum Ratings($T_a = 25\text{ }^\circ\text{C}$)

| Parameter | Symbol | Value | Unit |
|------------------------------------|-----------|------------|------------------|
| Power Dissipation | P_d | 260 | mW |
| Continuous Forward Current | I_F | 72 | mA |
| Peak Forward Current ^{※1} | I_{FP} | 200 | mA |
| Operating Temperature | T_{opr} | -30 ~ 85 | $^\circ\text{C}$ |
| Storage Temperature | T_{stg} | -40 ~100 | $^\circ\text{C}$ |
| Soldering Temperature | T_{sol} | 260 (5sec) | $^\circ\text{C}$ |

※1 Duty ratio = 1/10, Pulse width = 0.1ms

5. Electro-optical Characteristics($T_a = 25\text{ }^\circ\text{C}$)

| Parameter | Symbol | Conditions | Min. | Typ. | Max. | Unit. |
|----------------------------------|-----------------|----------------------|---------------------------------|------|------|----------|
| Forward Voltage | V_F | $I_F = 60\text{ mA}$ | 2.8 | 3.2 | 3.6 | V |
| Reverse Voltage | V_R | $I_R = 5\text{ mA}$ | 0.7 | 0.8 | 1.5 | V |
| Luminous Intensity ^{※2} | I_v | $I_F = 60\text{ mA}$ | 3000 | - | 6000 | mcd |
| Color Coordinates ^{※3} | CIE x CIE y | $I_F = 60\text{ mA}$ | Refer to Color Coordinates Rank | | | |
| Viewing Angle ^{※4} | $2\theta_{1/2}$ | $I_F = 60\text{ mA}$ | - | 120 | - | $^\circ$ |

※2 Luminous Intensity is tested by a tester calibrated by CAS 140B(CIE LED_B) and has an accuracy of 10%

※3 Color Coordinates has an accuracy of ± 0.01 .

※4 Viewing Angle is the angle until 50% of brightness measured from the front part of LED.

5.1 Luminous Intensity Rank

| Rank | Luminous Intensity (mcd) |
|------|--------------------------|
| B | 3000 – 4000 |
| C | 4000 – 5000 |
| D | 5000 – 6000 |

5.2 Forward Voltage Rank

| Rank | Forward Voltage (V) |
|------|---------------------|
| 0 | 2.8 ~ 3.0 |
| 2 | 3.0 ~ 3.2 |
| 4 | 3.2 ~ 3.4 |
| 6 | 3.4 ~ 3.6 |

5.3 Color Coordinates Rank ($I_F = 60 \text{ mA}$, $T_a = 25 \text{ }^\circ\text{C}$)

| BW | | | | CW | | | | | | | | | |
|-------------|--------|-------------|--------|-------------|--------|-------------|--------|-------------|--------|-------------|--------|-------------|--------|
| Z1 | | Z2 | | A1 | | A2 | | B1 | | B2 | | | |
| x | y | x | y | x | y | x | y | x | y | x | y | | |
| 0.2400 | 0.2000 | 0.2500 | 0.2100 | 0.2600 | 0.2200 | 0.2700 | 0.2300 | 0.2800 | 0.2400 | 0.2900 | 0.2500 | | |
| 0.2400 | 0.2600 | 0.2500 | 0.2700 | 0.2600 | 0.2800 | 0.2700 | 0.2900 | 0.2800 | 0.3000 | 0.2900 | 0.3100 | | |
| 0.2500 | 0.2700 | 0.2600 | 0.2800 | 0.2700 | 0.2900 | 0.2800 | 0.3000 | 0.2900 | 0.3100 | 0.3000 | 0.3200 | | |
| 0.2500 | 0.2100 | 0.2600 | 0.2200 | 0.2700 | 0.2300 | 0.2800 | 0.2400 | 0.2900 | 0.2500 | 0.3000 | 0.2600 | | |
| PW | | | | | | | | | | | | | |
| 7500K | | 7040K-4746K | | | | 6500K | | | | 5700K | | | |
| 8145-7040K | | 7040K-6020K | | 6020K-5331K | | 5331K-4746K | | 7040K-6530K | | 6530K-6020K | | 6020K-5665K | |
| Y | | V1 | | V2 | | V3 | | Z | | A | | B | |
| x | y | x | y | x | y | x | y | x | y | x | y | x | y |
| 0.3057 | 0.2671 | 0.3125 | 0.2842 | 0.3243 | 0.2951 | 0.3353 | 0.3053 | 0.3089 | 0.3012 | 0.3152 | 0.3070 | 0.3229 | 0.3142 |
| 0.2891 | 0.3175 | 0.3089 | 0.3012 | 0.3229 | 0.3142 | 0.3362 | 0.3259 | 0.3008 | 0.3399 | 0.3095 | 0.3484 | 0.3198 | 0.3585 |
| 0.3025 | 0.3321 | 0.3229 | 0.3142 | 0.3362 | 0.3259 | 0.3500 | 0.3371 | 0.3095 | 0.3484 | 0.3198 | 0.3585 | 0.3282 | 0.3652 |
| 0.3140 | 0.2770 | 0.3243 | 0.2951 | 0.3353 | 0.3053 | 0.3472 | 0.3164 | 0.3152 | 0.3070 | 0.3229 | 0.3142 | 0.3292 | 0.3200 |
| PW | | | | | | NW | | | | | | | |
| 5700K | | 5000K | | | | 4500K | | | | | | | |
| 5665K-5311K | | 5311K-5028K | | 5028K-4746K | | 4746K-4503K | | 4503K-4260K | | 4260K-3985K | | 3985K-3710K | |
| C | | L | | M | | D | | E | | F | | G | |
| x | y | x | y | x | y | x | y | x | y | x | y | x | y |
| 0.3292 | 0.3200 | 0.3362 | 0.3259 | 0.3429 | 0.3317 | 0.3500 | 0.3371 | 0.3574 | 0.3428 | 0.3648 | 0.3479 | 0.3755 | 0.3550 |
| 0.3282 | 0.3652 | 0.3381 | 0.3732 | 0.3465 | 0.3797 | 0.3562 | 0.3843 | 0.3650 | 0.3899 | 0.3756 | 0.3966 | 0.3882 | 0.4044 |
| 0.3381 | 0.3732 | 0.3465 | 0.3797 | 0.3567 | 0.3881 | 0.3650 | 0.3899 | 0.3756 | 0.3966 | 0.3882 | 0.4044 | 0.4035 | 0.4134 |
| 0.3362 | 0.3259 | 0.3429 | 0.3317 | 0.3500 | 0.3371 | 0.3574 | 0.3428 | 0.3648 | 0.3479 | 0.3755 | 0.3550 | 0.3865 | 0.3617 |
| WW | | | | | | | | | | | | | |
| 3500K | | | | 3000K | | | | 2700K | | | | | |
| 3710K-3465K | | 3465K-3220K | | 3220K-3045K | | 3045K-2870K | | 2870K-2670K | | 2670K-2500K | | | |
| J | | K | | P | | Q | | R | | S | | | |
| x | y | x | y | x | y | x | y | x | y | x | y | | |
| 0.3865 | 0.3617 | 0.3988 | 0.3684 | 0.4117 | 0.3745 | 0.4221 | 0.3790 | 0.4599 | 0.4329 | 0.4767 | 0.4360 | | |
| 0.4022 | 0.4094 | 0.4165 | 0.4169 | 0.4332 | 0.4241 | 0.4456 | 0.4287 | 0.4767 | 0.4360 | 0.4921 | 0.4374 | | |
| 0.4165 | 0.4169 | 0.4332 | 0.4241 | 0.4456 | 0.4287 | 0.4599 | 0.4329 | 0.4486 | 0.3875 | 0.4621 | 0.3902 | | |
| 0.3988 | 0.3684 | 0.4117 | 0.3745 | 0.4221 | 0.3790 | 0.4344 | 0.3833 | 0.4344 | 0.3833 | 0.4486 | 0.3875 | | |

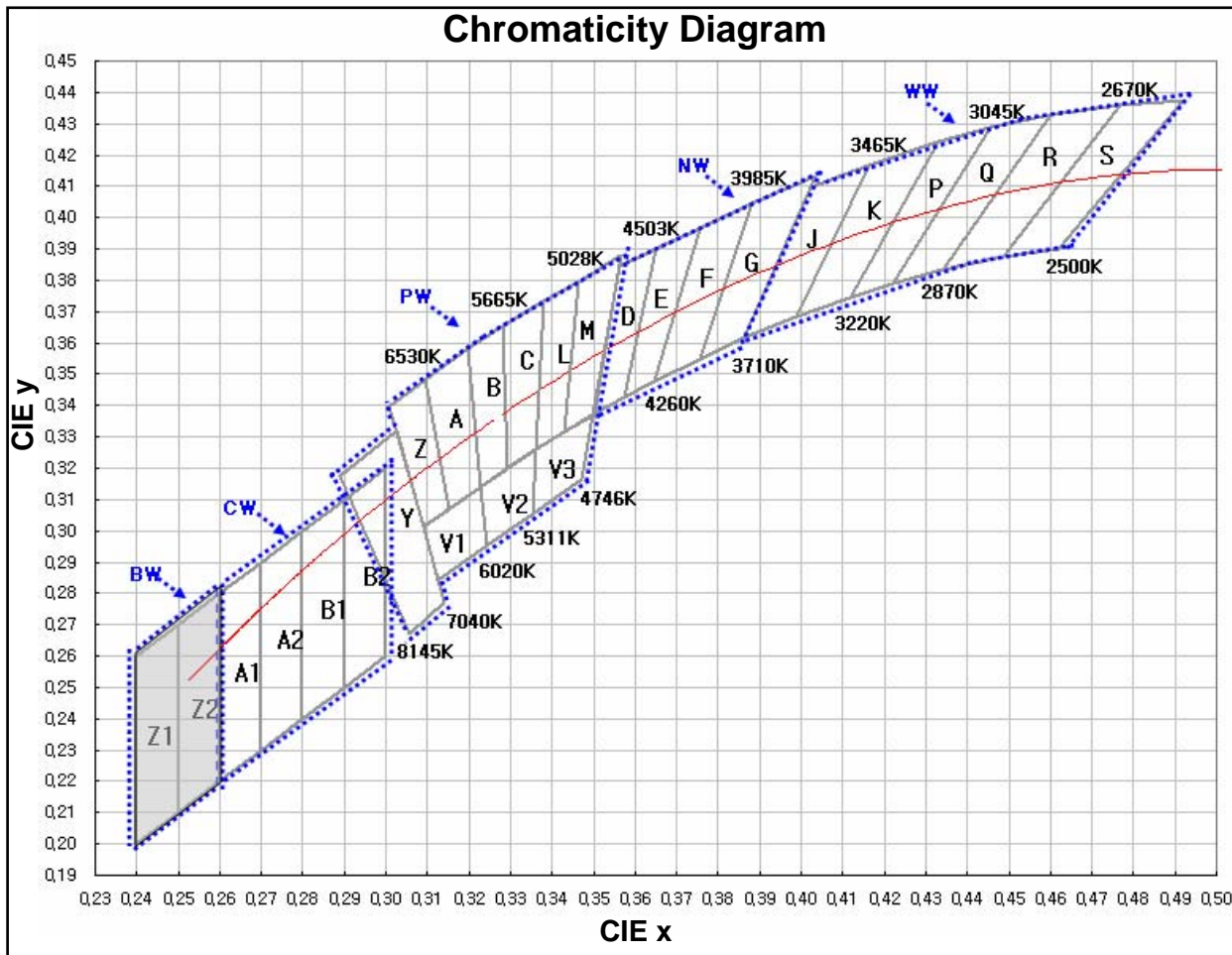

6. Typical Characteristics Curves

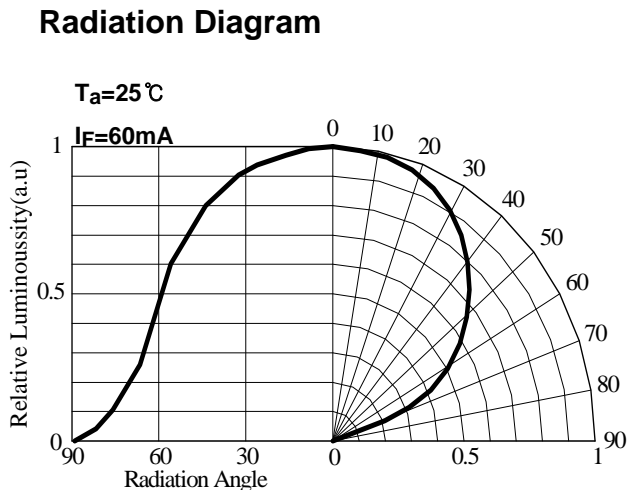
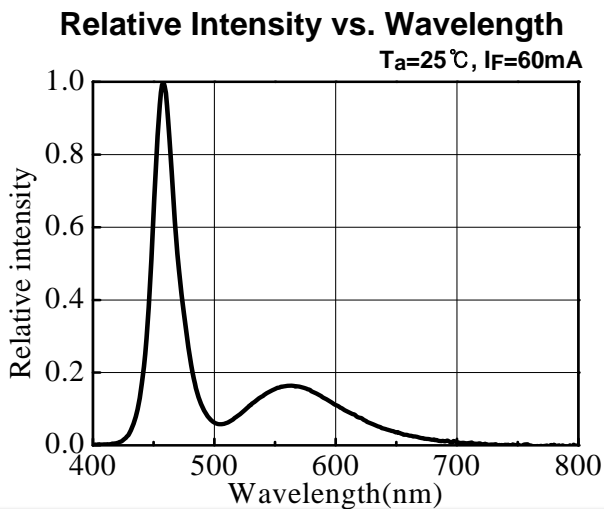
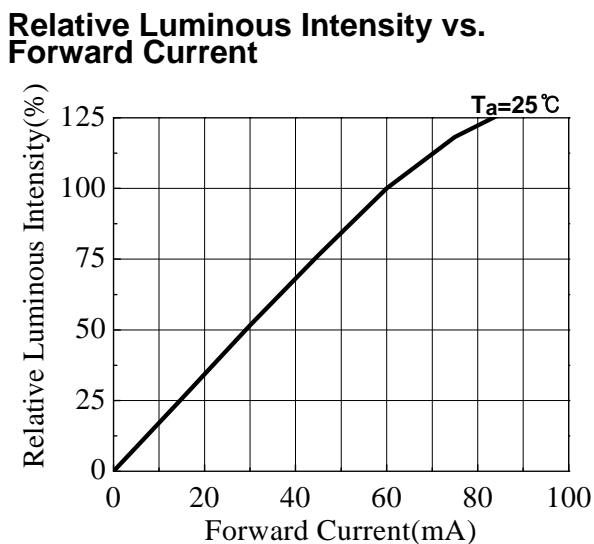
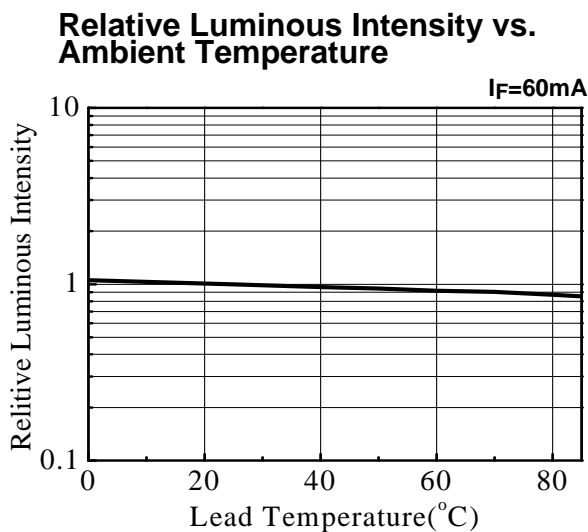
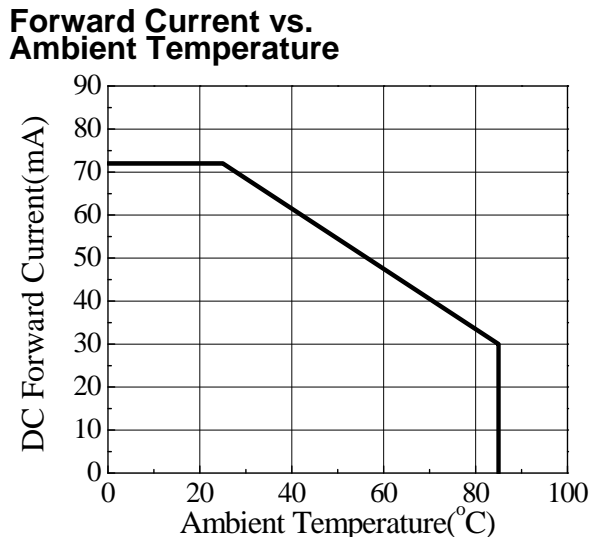
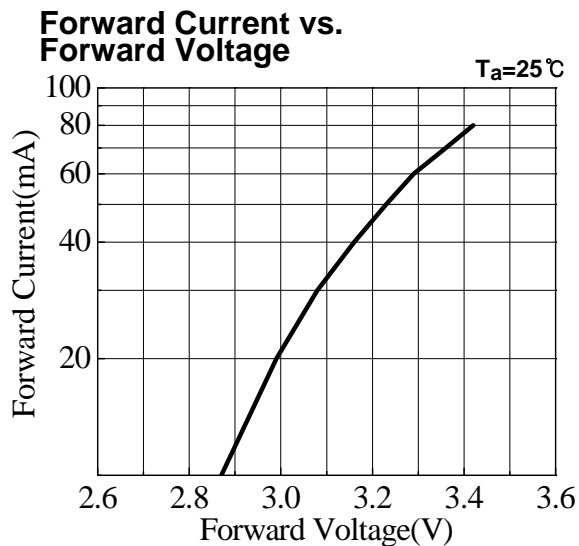

7. Dimension of Tape / Reel

7.1 Tape Dimension

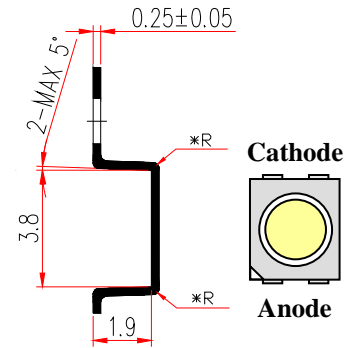
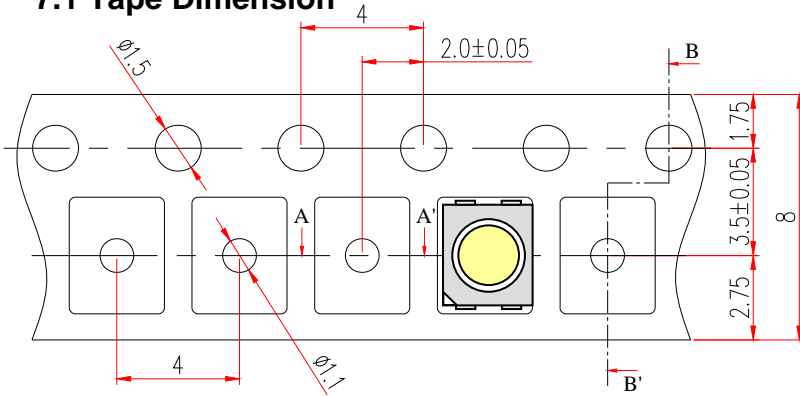

< SECTION B-B' >

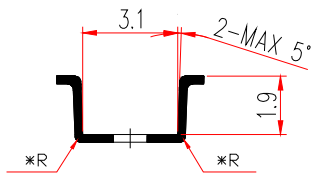

< SECTION A-A' >

Tolerance ±0.1 , Unit: mm

7.2 Reel Dimension

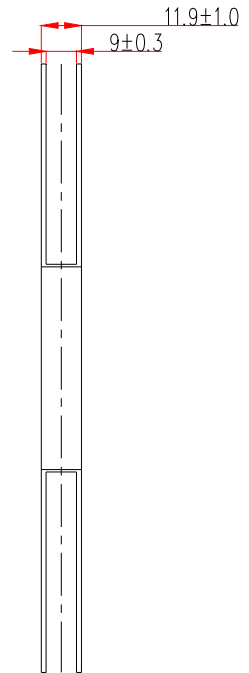
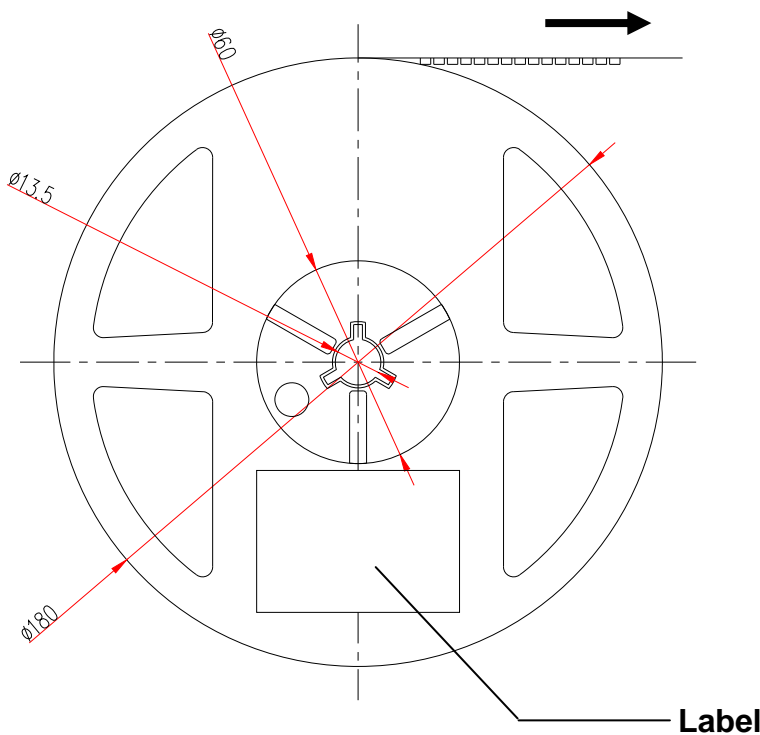

Label

8. Packing Dimension

Unit :mm

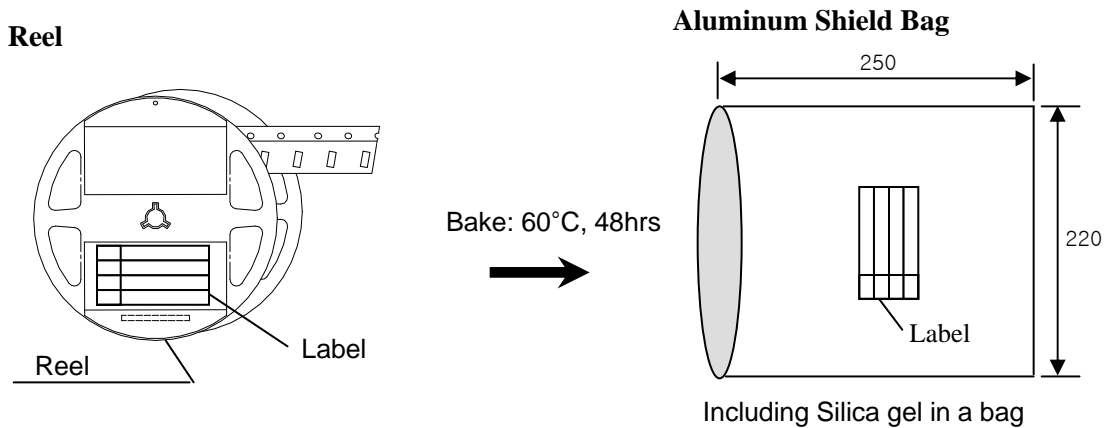

AI Pack Label, Reel Label (70 × 37)

| | | | | |
|-----------------------|-----------------|-----|-----|-----|
| ITSWELL | | | | |
| Lot : | IWS-L3514-BW-K3 | | | |
| | MIN | AVG | MAX | STD |
| V _f [volt] | | | | |
| I _v [mcd] | | | | |
| CCT[K] | | | | |
| Q'ty : | yyyy/mm/dd | | | |

Card Board Box

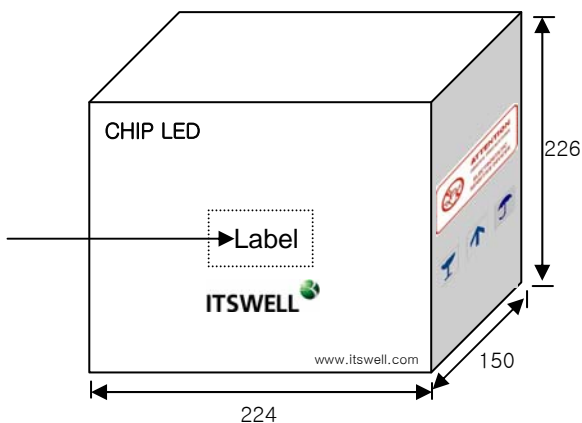

| | Dimensions (mm) | Reel / Box | Q'ty / Box(pcs) |
|----------------|-----------------------|------------|-----------------|
| Reel | Φ180mm, 12mm Width | - | 2,000 Max |
| Al Shield Bag | 250x220 | - | 2,000 Max |
| Card Board Box | 224x150x226 | 10 Max | 20,000 Max |

9. Precaution in use

9.1 Soldering Conditions

- When soldering Power SMD, Heat may affect the electrical and optical characteristics of the LEDs.
- In soldering, do not stress the lead frame and the resin part under the high temperature.
- The silicone part should be protected from mechanical stress or vibration until the Power SMD return to room temperature after soldering.
- Preliminary heating to be at 160 °C max. for 120 Seconds max.
- Soldering heat to be at 260 °C max. for 5 sec. Max.
- For manual Soldering is Not more than 3 sec @MAX 350 °C, under soldering iron

< Lead Free >

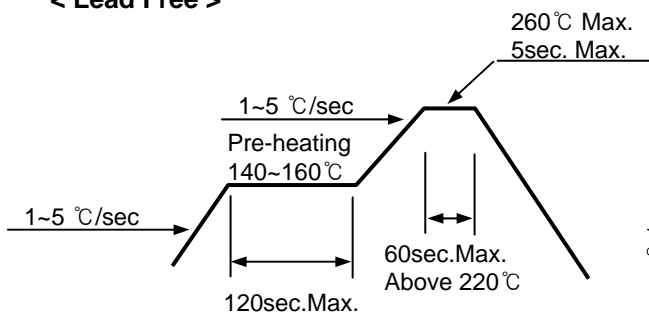

<Recommendable soldering pattern>

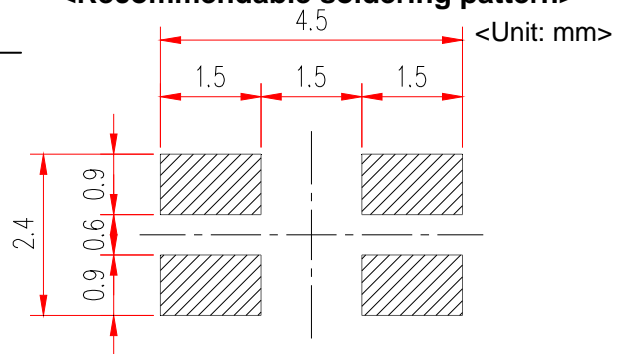

9.2 Storage

- Before opening the package, the LEDs should be kept at 30 °C or less and 70%RH or less.
- The LEDs should be used within a year.
- After opening the package, the LEDs should be kept at 30 °C or less and 30%RH or less.
- The LEDs should be used within 168 hours (7 day) after opening the package.
- If the moisture absorbent material (silicagel) has faded away or the LED have exceeded the storage time, baking treatment should be performed using the following conditions.
Baking treatment: 60 °C ±5 for 24 hours.

9.3 Static Electricity

- Static electricity or surge voltage damages the Power SMD . It is recommended that a wrist band or an anti-electrostatic glove be used when handling the LEDs.
- A tip soldering iron is requested to be grounded. An ionizer should also be installed where risk of static.
- All devices, equipment and machinery must be properly grounded (via 1MΩ). It is recommended that measures be taken against surge voltage to the equipment that mounts the Power SMD.

9.4 Cleaning

- Isopropyl Alcohol or Ethylene Alcohol is recommended in 5 minutes at room temperature.
Don't use unspecified chemical may cause crack or haze on the surface of the epoxy resin.
- Before cleaning, a pre-test should be done to confirm whether any damage to the LED will occur.
- Freon solvents should not be used to clean the LEDs because of worldwide regulations.

9.5 Heat Generation

- When the LEDs are illuminating, operating current should be decided after being considering the ambient maximum temperature.
- Please consider the heat generation of the LED when it is designed the PCB.

10. Reliability

10.1 Reliability Test Item

| Test Items | Test Conditions | Notes |
|---|---|-------|
| High Temperature Storage | 100°C, 1,000hr. | 0/25 |
| Low Temperature Storage | -40°C, 1,000hr. | 0/25 |
| Temp. Humidity Storage | 60°C, 90% RH, 1,000hr. | 0/25 |
| Steady State Operating life | 25°C, 72mA, 1,000hr. | 0/25 |
| High Temperature Operating Life | 85°C, 30mA, 1,000hr | 0/25 |
| Low Temperature Operating Life | -30°C, 60mA, 1,000hr. | 0/25 |
| Steady State Operating life Of High Humidity Heat | 60°C, 90% RH, 45mA, 1,000hr. | 0/25 |
| Thermal Shock | -40°C (30min)↔100°C (30min.), 100 cycle | 0/20 |
| ESD | HBM, 100 pF, 1.5 kohm, 3 times | 0/20 |

10.2 Criteria for Judging the Damage

| Parameters | Test Conditions | Criteria for judgment |
|------------------------------|-----------------------|-----------------------|
| Forward Voltage (V_F) | $I_F = 60 \text{ mA}$ | Less than 110% of U |
| Luminous Intensity (I_V) | $I_F = 60 \text{ mA}$ | > 70% of S |

* U means the upper limit of specified characteristics, S means initial value.

11. Part Name Description

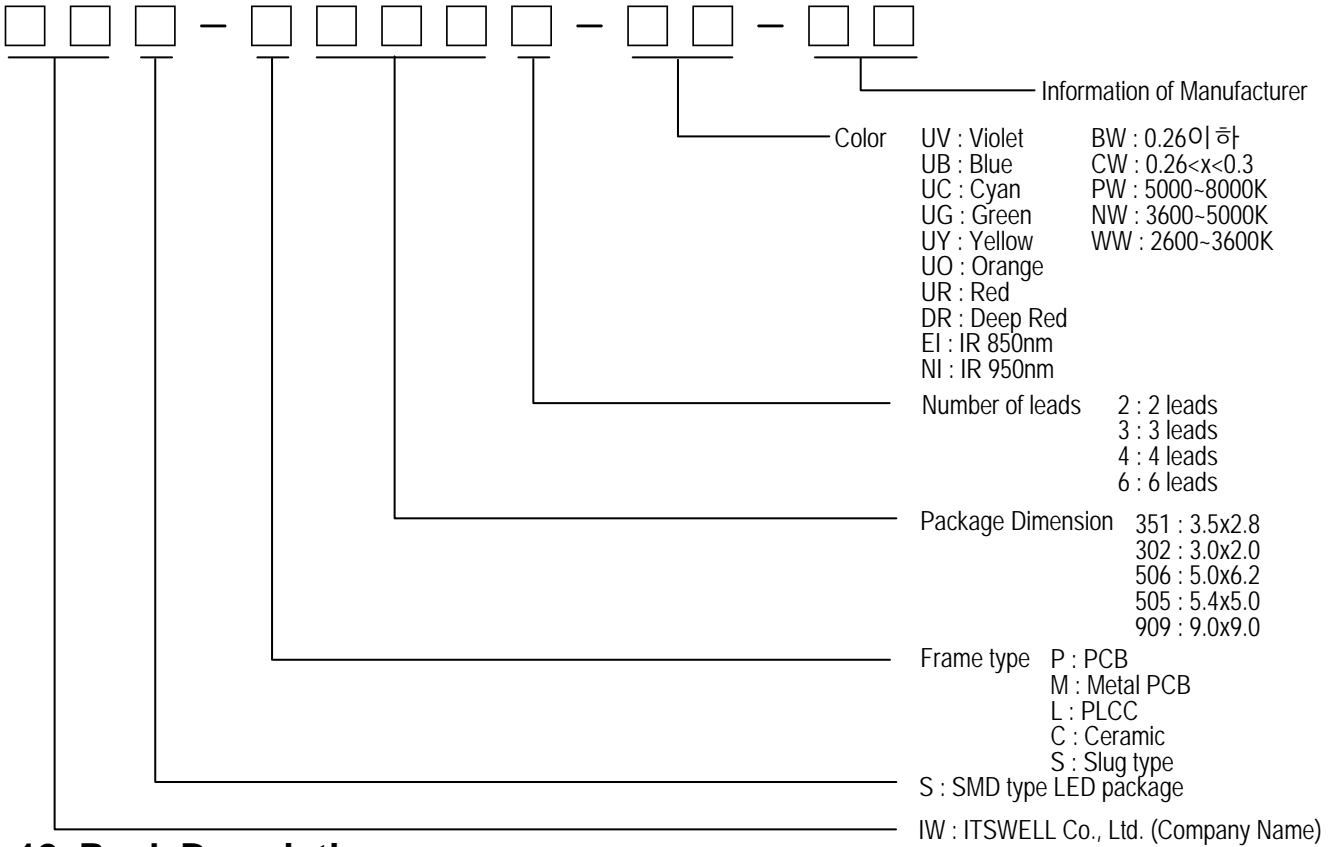

12. Rank Description

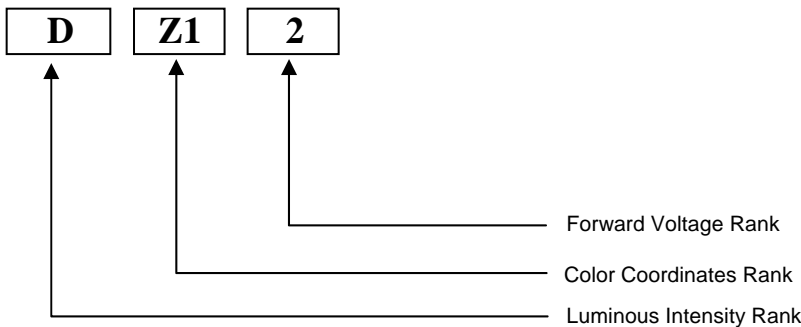

13. Attention : Electric Static Discharge (ESD) Protection



The symbol shown on the page herein to introduce 'Electro-Optical Characteristics'. ESD protection for GaP and AlGaAs based chips is still Necessary even though they are safe in low static-electric discharge. Material in AlInGaP, GaP, or/and InGaN based chips are STATIC SENSITIVE devices. ESD protection has to considered and taken in the initial design stage. If manual work/process is needed, please ensure the device is well protective from ESD during all the process.

