

Preliminary

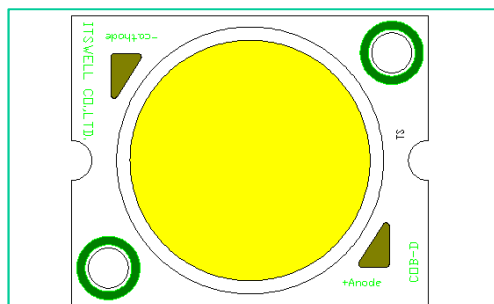

Product : Multi Chip Array LED (10W)

Part No. : IWC-B10R2-P7-D5601

Date : 2012. 12. 10 Ver 0.1

Proposed By	Checked By	Checked By	Checked By	Approval

Comment



Incheon Company :
58B-4L, 626-3 Gojan-dong, Namdong-gu, Incheon 405-817 KOREA
TEL:+82-32-813-1910, FAX:+82+32-822-9009
URL: <http://www.itswell.com>,

Contents

1. Product Outline	3
2. Outline Drawing and Dimension	3
3. Absolute Maximum Rating	4
4. Electrical & Optical Characteristics	4
5. Rank (Luminous Flux, Forward Voltage, Color Coordinates)	5
6. Typical Characteristic Curve	7
7. Dimension of Tray	9
8. Packing Dimension	10
9. Precaution in Use	11
10. Reliability	14
11. Part Name Description	15
12. Laser Making Description	15
13. Attention : Electric Static Discharge(ESD) Protection	15
14. Revision History	16

Multi Chip Array LED (10W)

IWC-B10R2-P7-D5601



1. Product Outline

1.1 Features

- High Power and High Efficiency Package
- Chip on Board Type Multi Chip Array
- Higher Energy Efficient than Incandescent, Halogen and Some Fluorescent Lamps
- Long Operating Life

1.2 Applications

- General Lighting and Interior Lighting
- Indoor Lighting for Incandescent and Halogen Lamps
- Flood Lighting

2. Outline Drawing and Dimension

Unit : mm
Tolerance : ± 0.2

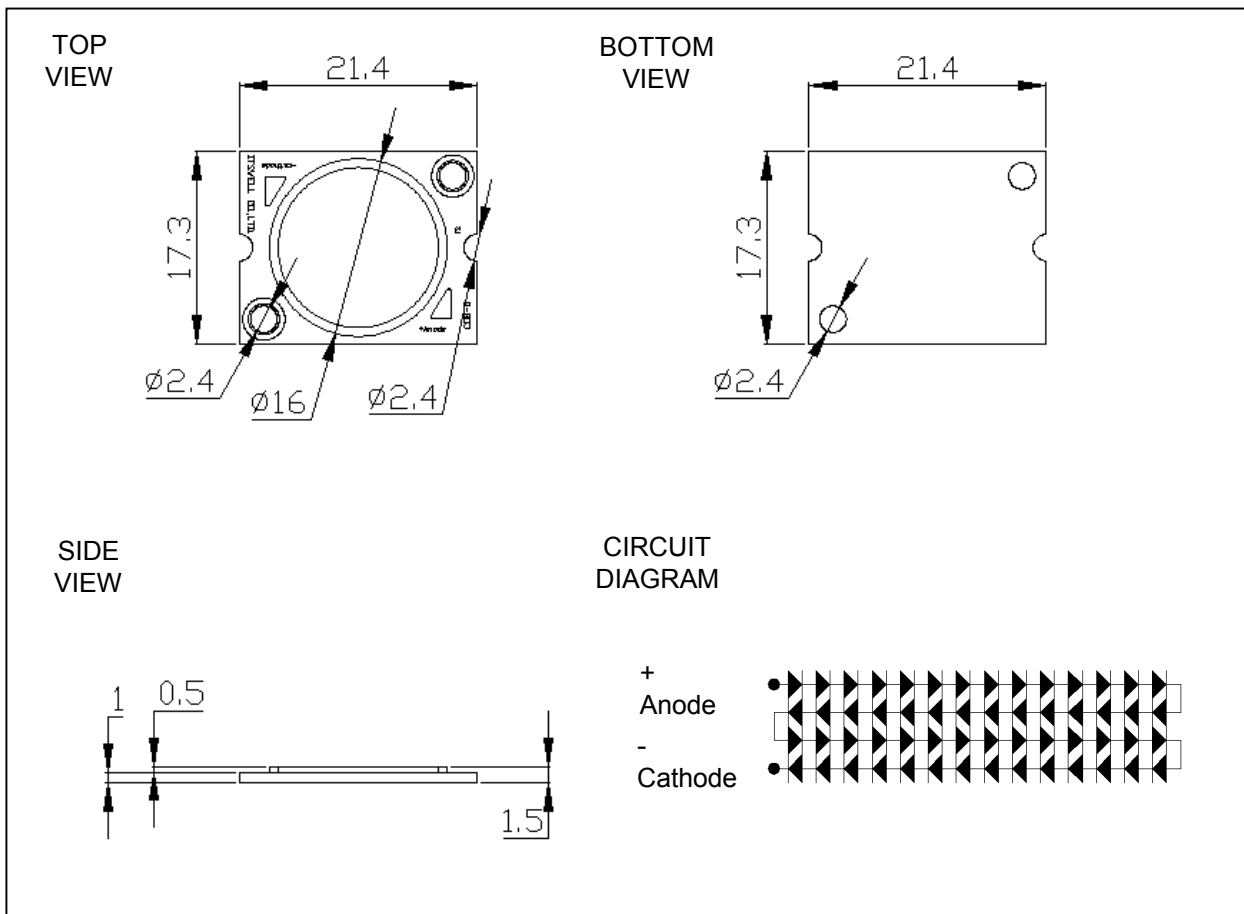

Note

1. All dimensions are in millimeters
2. All dimensions without tolerances are for reference only

Multi Chip Array LED (10W)

IWC-B10R2-P7-D5601



3. Absolute Maximum Ratings (Ta : 25 °C)

Parameter	Symbol	Value	Unit
Power Dissipation	P_d	14.4	W
Continuous Forward Current	I_F	80	mA
Peak Forward Current *1	I_{FP}	120	mA
Operating Temperature	T_{opr}	-30 ~ +85	°C
Storage Temperature	T_{stg}	-40 ~ +100	°C
Junction Temperature	T_{jmax}	120	°C
Thermal Resistance	$R_{th J-S}^{*2}$	0.75	K/W

*1 Duty ratio = 1/10, Pulse width = 10ms

*2 J = Junction S= Substrate

4. Electrical & Optical Characteristics (Ta : 25 °C)

Parameter	Symbol	Condition	Min.	Typ.	Max.	Unit.
Forward Voltage	V_F	$I_F = 60mA$	160.0		180.0	V
Color Coordinates	CIE x CIE y		Refer to Color Coordinates Rank			
General Color Rendering Index	RA		75			
Luminous Flux*2	Φ_V		800	-	1200	lm
View Angle*3	$2\theta_{1/2}$		-	120	-	deg.

*2 Luminous Flux is measured with an integrating sphere and has an accuracy of 10%

*3 Viewing angle is the angle until 50% of brightness measured from the front part of LED.

Multi Chip Array LED (10W)

IWC-B10R2-P7-D5601



5. Rank (IF = 60mA, Ta = 25°C)

5.1 Luminous Flux Rank

Rank	Luminous Flux (lm)
L08	800 ~ 900
L09	900 ~ 1000
L10	1000 ~ 1100
L11	1100 ~ 1200

5.2 Forward Voltage Rank

Rank	Forward Voltage(V)
HV160	160.0 ~ 165.0
HV165	165.0 ~ 170.0
HV170	170.0 ~ 175.0
HV175	175.0 ~ 180.0

5.3 Color Coordinates Rank

BW				CW									
Z1		Z2		A1		A2		B1		B2			
x	y	x	y	x	y	x	y	x	y	x	y		
0.2400	0.2000	0.2500	0.2100	0.2600	0.2200	0.2700	0.2300	0.2800	0.2400	0.2900	0.2500		
0.2400	0.2600	0.2500	0.2700	0.2600	0.2800	0.2700	0.2900	0.2800	0.3000	0.2900	0.3100		
0.2500	0.2700	0.2600	0.2800	0.2700	0.2900	0.2800	0.3000	0.2900	0.3100	0.3000	0.3200		
0.2500	0.2100	0.2600	0.2200	0.2700	0.2300	0.2800	0.2400	0.2900	0.2500	0.3000	0.2600		
PW													
7500K		7040K-4746K				6500K		5700K					
8145-7040K		7040K-6020K		6020K-5331K		5331K-4746K		7040K-6530K		6530K-6020K		6020K-5665K	
Y		V1		V2		V3		Z		A		B	
x	y	x	y	x	y	x	y	x	y	x	y	x	y
0.3057	0.2671	0.3125	0.2842	0.3243	0.2951	0.3353	0.3053	0.3089	0.3012	0.3152	0.3070	0.3229	0.3142
0.2891	0.3175	0.3089	0.3012	0.3229	0.3142	0.3362	0.3259	0.3008	0.3399	0.3095	0.3484	0.3198	0.3585
0.3025	0.3321	0.3229	0.3142	0.3362	0.3259	0.3500	0.3371	0.3095	0.3484	0.3198	0.3585	0.3282	0.3652
0.3140	0.2770	0.3243	0.2951	0.3353	0.3053	0.3472	0.3164	0.3152	0.3070	0.3229	0.3142	0.3292	0.3200
PW						NW							
5700K		5000K				4500K							
5665K-5311K		5311K-5028K		5028K-4746K		4746K-4503K		4503K-4260K		4260K-3985K		3985K-3710K	
C		L		M		D		E		F		G	
x	y	x	y	x	y	x	y	x	y	x	y	x	y
0.3292	0.3200	0.3362	0.3259	0.3429	0.3317	0.3500	0.3371	0.3574	0.3428	0.3648	0.3479	0.3755	0.3550
0.3282	0.3652	0.3381	0.3732	0.3465	0.3797	0.3562	0.3843	0.3650	0.3899	0.3756	0.3966	0.3882	0.4044
0.3381	0.3732	0.3465	0.3797	0.3567	0.3881	0.3650	0.3899	0.3756	0.3966	0.3882	0.4044	0.4035	0.4134
0.3362	0.3259	0.3429	0.3317	0.3500	0.3371	0.3574	0.3428	0.3648	0.3479	0.3755	0.3550	0.3865	0.3617
WW													
3500K				3000K				2700K					
3710K-3465K		3465K-3220K		3220K-3045K		3045K-2870K		2870K-2670K		2670K-2500K			
J		K		P		Q		R		S			
x	y	x	y	x	y	x	y	x	y	x	y	x	y
0.3865	0.3617	0.3988	0.3684	0.4117	0.3745	0.4221	0.3790	0.4599	0.4329	0.4767	0.4360	0.4767	0.4360
0.4022	0.4094	0.4165	0.4169	0.4332	0.4241	0.4456	0.4287	0.4767	0.4360	0.4921	0.4374	0.4921	0.4374
0.4165	0.4169	0.4332	0.4241	0.4456	0.4287	0.4599	0.4329	0.4486	0.3875	0.4621	0.3902	0.4621	0.3902
0.3988	0.3684	0.4117	0.3745	0.4221	0.3790	0.4344	0.3833	0.4344	0.3833	0.4486	0.3875	0.4486	0.3875

Multi Chip Array LED (10W)

IWC-B10R2-P7-D5601

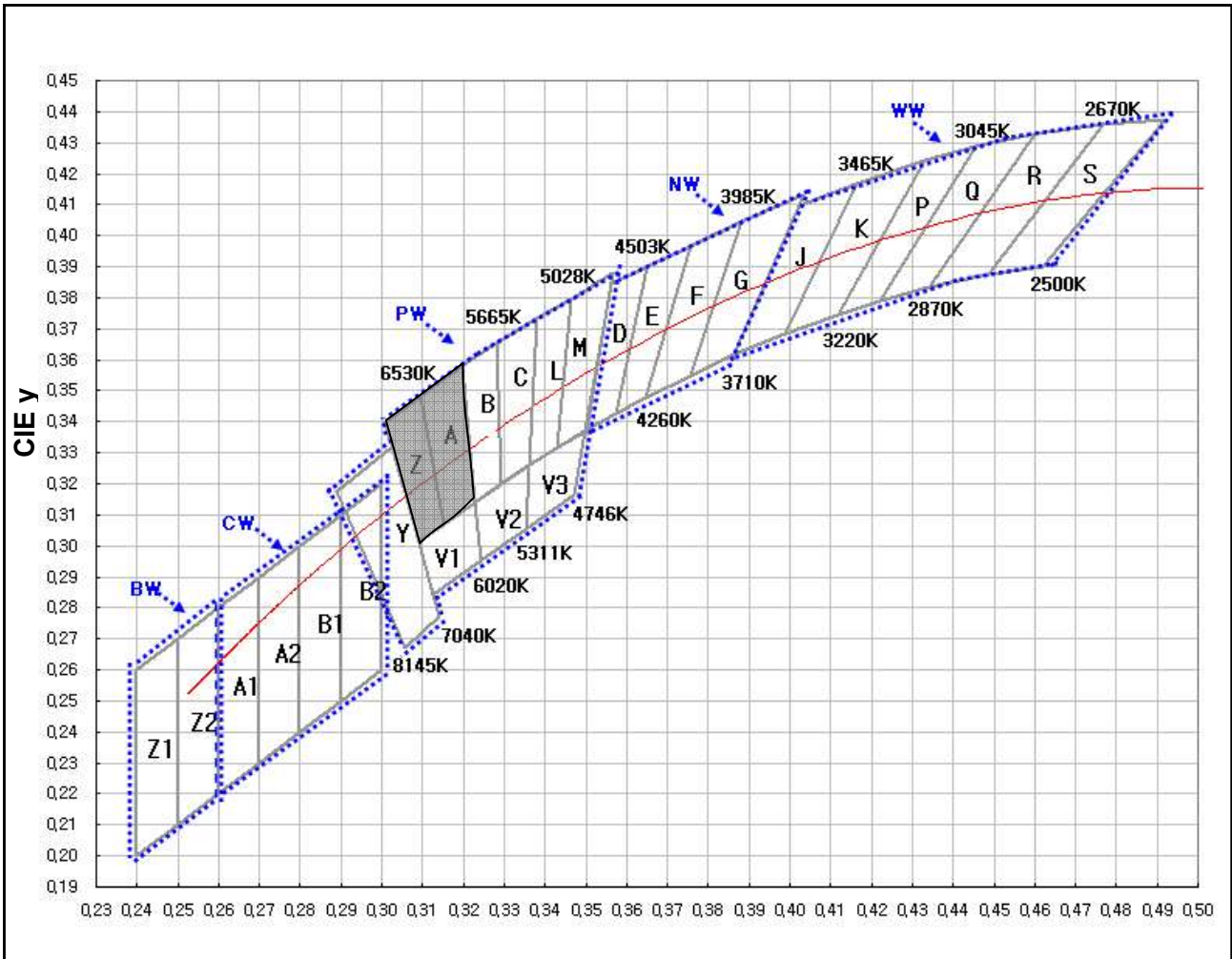

6. Typical Characteristic Curve

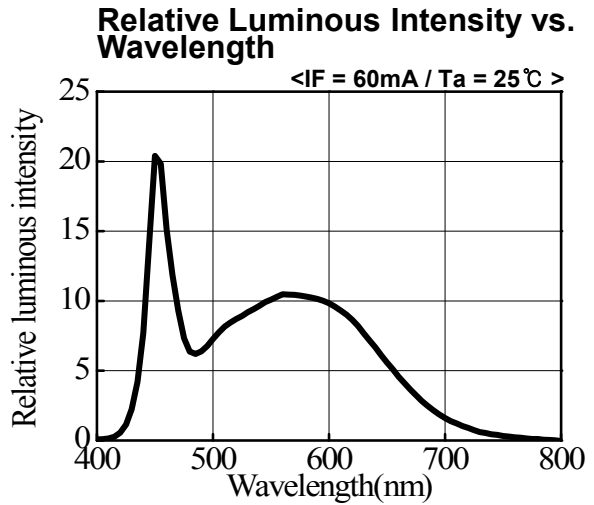
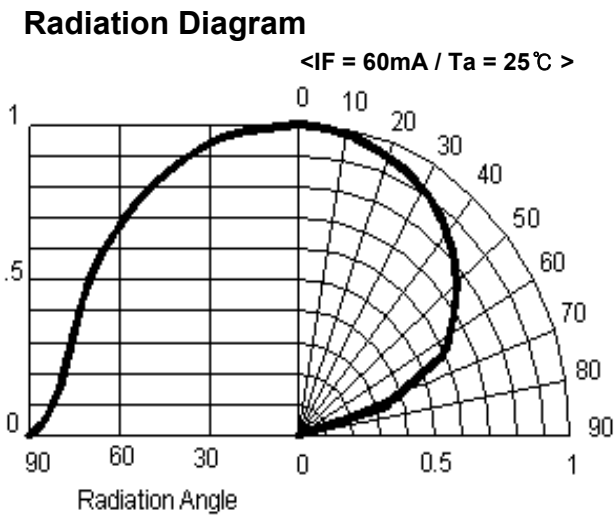
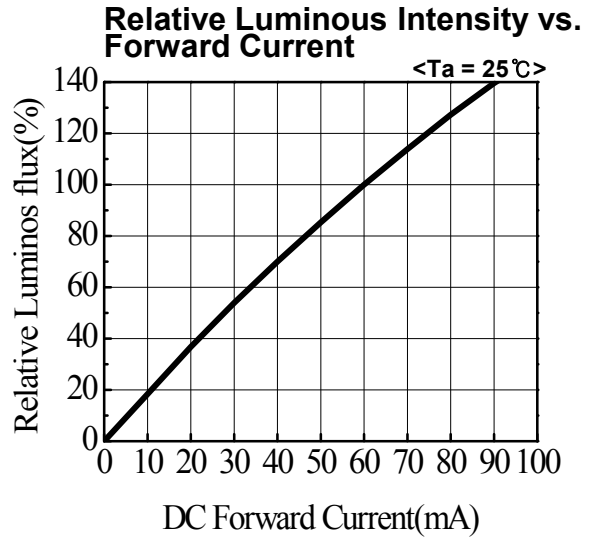
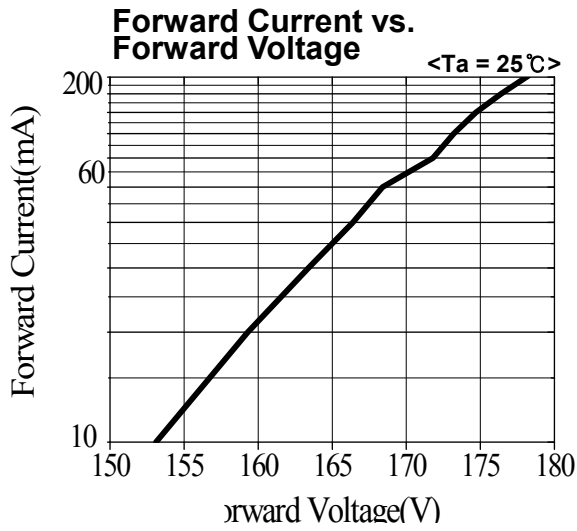

Multi Chip Array LED (10W)

IWC-B10R2-P7-D5601



Forward Current vs. Substrate Temperature

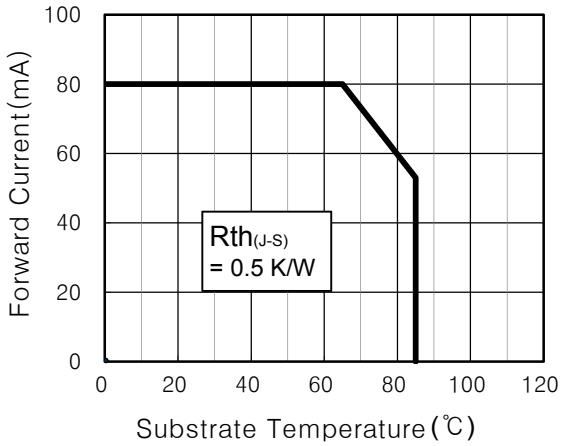

Relative Luminous Intensity vs. Substrate Temperature

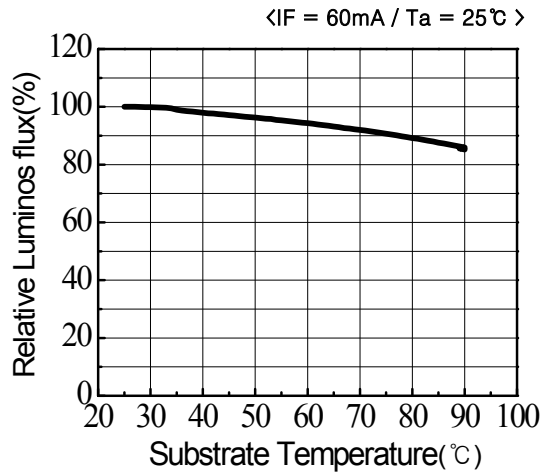

Color CIE x, y vs. Substrate Temperature

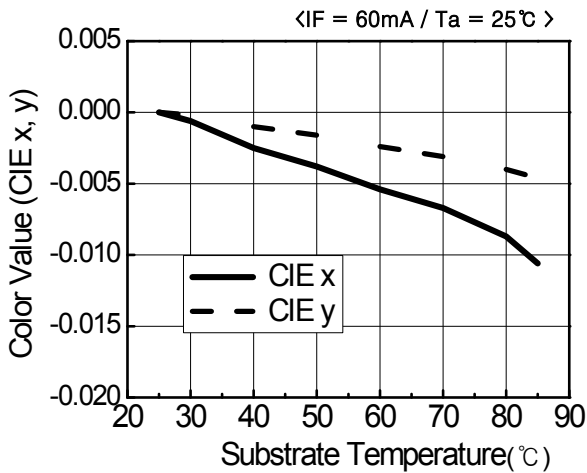

7. Dimension of Tray

7.1 Tray Pocket

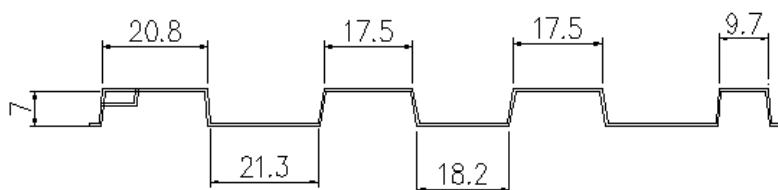

7.2 Tray Dimension

< Unit : mm / Tolerance : ±0.5mm >

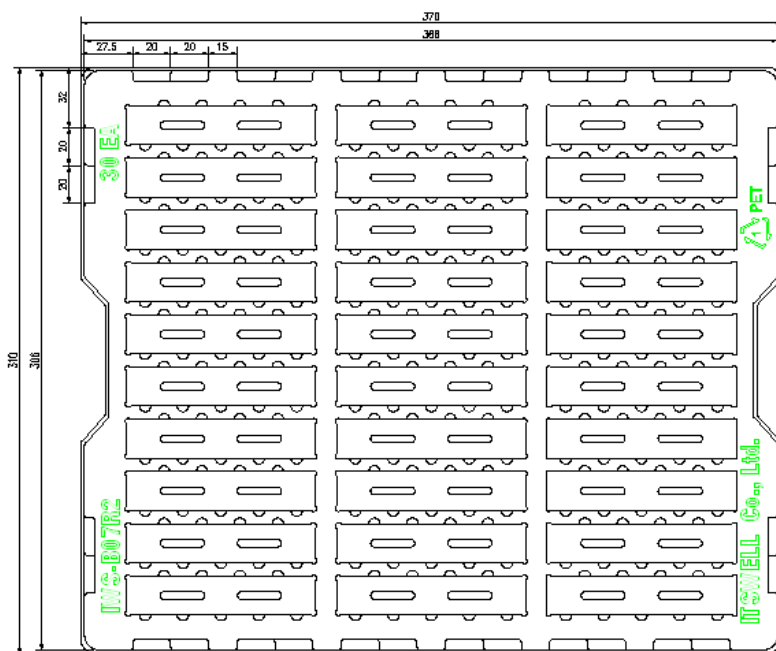

Multi Chip Array LED (10W) IWC-B10R2-P7-D5601



8. Packing Dimension

< Unit : mm / Tolerance : ±0.1mm >

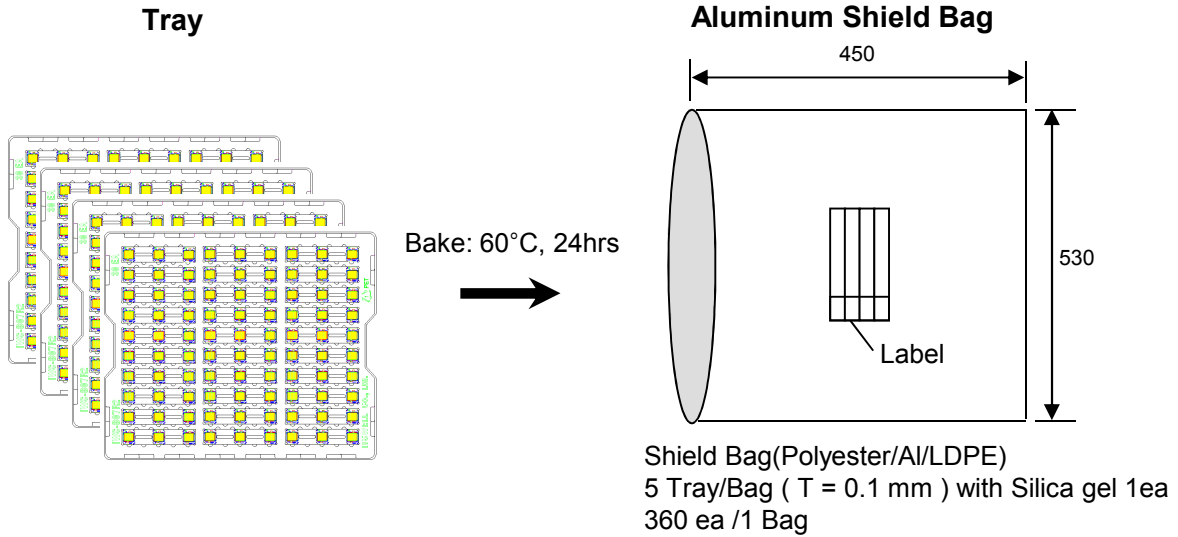

Al Pack Label, Tray Label (70 × 37)

ITSWELL				
Lot :		IWC-BXXR2-XX-XXXXX		
	MIN	AVG	MAX	STD
VF				
CCT				
CRI				
Q'ty : ea		yyyy/mm/dd		

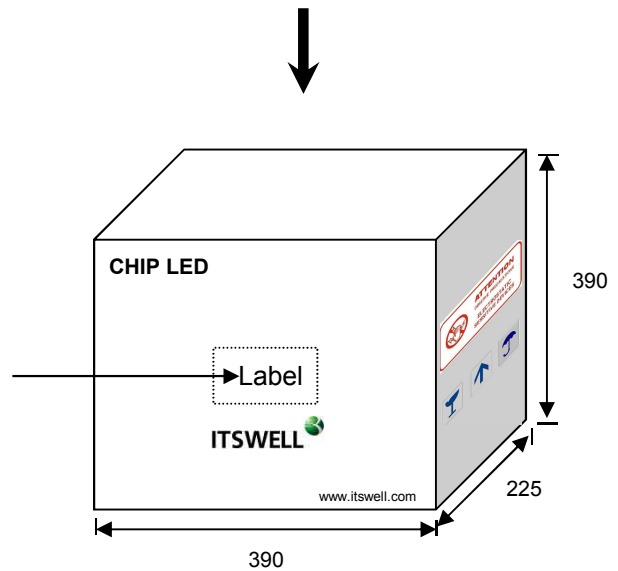

	Dimensions (mm)	Tray / Box	Q'ty / Box(ea)
Tray	370 x 310	–	90
Al Shield Bag	450 x 530	–	900
Outer Box	390 x 225 x 390	2 Max	1800 Max

9. Precaution in use

9.1 Assembly Method

- A thin layer of thermal grease should be applied to the bottom surface of the array, between the bottom of the array the heat sink. All air gaps and voids between the heat sink and array should be eliminated.
- Ensure that sufficient thermal grease is used to cover the entire bottom surface of the array, but not so much that the thermal grease creeps up to the top of the array.
- Product should be firmly secured onto appropriate heat sink by fastening M2 screws on 2 positions of the product. The use of hard non - electrically conductive that washers with lock washers in recommended.

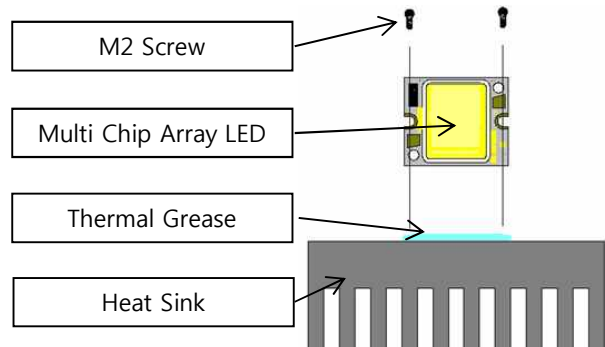

<Assembly Drawing>

9.2 Handling

- Do not touch the optical area of the Multi Chip Array LED
- Avoid and contact With the optical area
- Applying stress to the phosphor resin area can result in damage to the Multi Chip Array LED

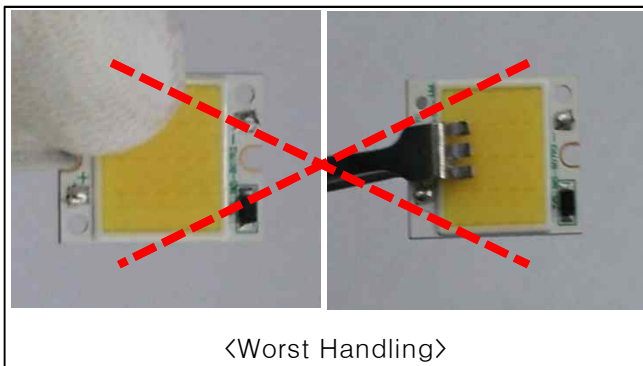
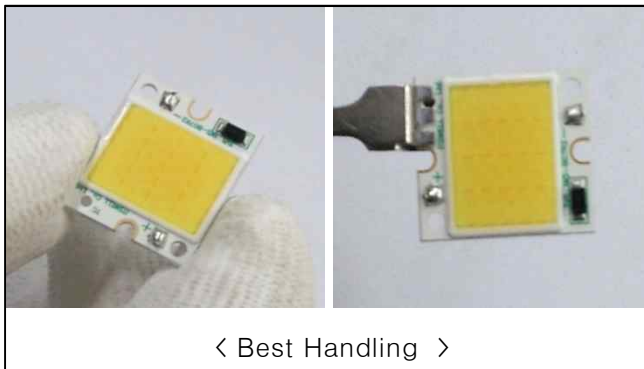

9.3 Recommend Soldering Profile

- The Assembly process enables the solder pads of the LED Arrays to reach 255 ~260°C (7~10sec) to ensure consistent melting of this solder paste.
Peak Temp Max. 260 / Peak Time Max 10sec

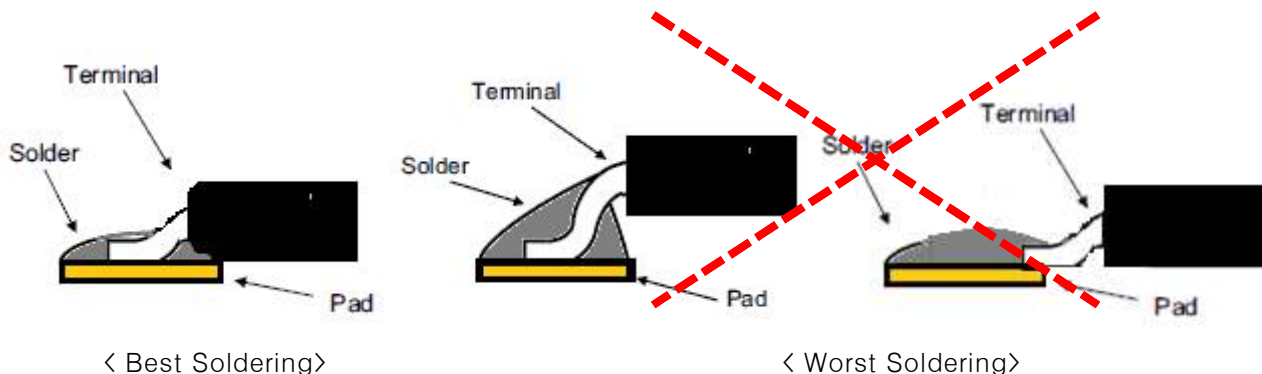

9.4 Storage

- Before opening the package, the LEDs should be kept at 30°C or less and 70%RH or less.
- The LEDs should be used within a year.
- After opening the package, the LEDs should be kept at 30°C or less and 30%RH or less.
- The LEDs should be used within 572 hours (4 Week) after opening the package.
- If the moisture absorbent material (silicagel) has faded away or the LED have exceeded the storage time, baking treatment should be performed using the following conditions.
Baking treatment: 60°C ±5 for 24 hours.

9.5 Static Electricity

- Static electricity or surge voltage damages the LEDs. It is recommended that a wrist band or an anti-electrostatic glove be used when handling the LEDs.
- A tip soldering iron is requested to be grounded. An ionizer should also be installed where risk of static.
- All devices, equipment and machinery must be properly grounded (via 1MΩ). It is recommended that measures be taken against surge voltage to the equipment that mounts the Power SMD.

9.6 Cleaning

- Isopropyl Alcohol or Ethylene Alcohol is recommended in 5 minutes at room temperature. Don't use unspecified chemical may cause crack or haze on the surface of the epoxy resin.
- Before cleaning, a pre-test should be done to confirm whether any damage to the LED will occur.
- Freon solvents should not be used to clean the LEDs because of worldwide regulations.

9.7 Heat generation

- When the LEDs are illuminating, operating current should be decided after being considering the ambient maximum temperature.
- Please consider the heat generation of the LED when it is designed the PCB.
- The LED's must be mounted on MCPCB or heat sink or applied thermal pad.

Multi Chip Array LED (10W)

IWC-B10R2-P7-D5601



9.8 JEDEC Information

JEDEC has defined a moisture sensitivity classification. So that the users can properly store and Handle the devices and to avoid subsequent thermal and mechanical damage during the assembly reflow attachment or repair operation.

The present moisture sensitivity standard contains six levels, the lower the level, the longer the devices floor life.

Level	Floor Life		Soak Requirements				
			Standard		Accelerated Equivalent		
	Time	Condition	Time (hrs)	condition	0.40~0.48eV Time (hrs)	0.40~0.48eV Time (hrs)	condition
1	Unlimited	≤30℃/85% RH	168 +5/-0	85℃/85% RH	N/A	N/A	N/A
2	1 year	≤30℃/60% RH	168 +5/-0	85℃/60% RH	N/A	N/A	N/A
2a	4 week	≤30℃/60% RH	696 +5/-0	30℃/60% RH	120 +1/-0	168 +1/-0	60℃/60% RH
3	168 hrs	≤30℃/60% RH	192 +5/-0	30℃/60% RH	40 +1/-0	52 +5/-0	60℃/60% RH
4	72 hrs	≤30℃/60% RH	96 +5/-0	30℃/60% RH	20 +1/-0	24 +5/-0	60℃/60% RH
5	48 hrs	≤30℃/60% RH	72 +5/-0	30℃/60% RH	15 +1/-0	20 +5/-0	60℃/60% RH
5a	24 hrs	≤30℃/60% RH	48 +5/-0	30℃/60% RH	10 +1/-0	13 +5/-0	60℃/60% RH
6	Time On Level (TOL)	≤30℃/60% RH	TOL	30℃/60% RH	N/A	N/A	N/A

<Note>

1. The standard soak time includes a default value of 24 hour for semiconductor manufacture's exposure time between bake and bag, and includes the maximum time allowed out of the bag at the distributor's facility
2. Joint Electron Devices Engineering Councils (JEDEC) is the leading developer of standards for the solid-state industry. Almost 3100 participants, appointed by some 290 companies work together in 50 JEDEC committees to meet the needs of every segment of the industry, manufacturers and consumers alike. The publications and standards that they generate are accepted throughout the world. (<http://www.jedec.org>)

10. Reliability

10.1 Reliability Test Item

Test Items	Test Conditions	Notes
High Temperature Storage	100℃, 1,000hr.	0/5
Low Temperature Storage	-40℃, 1,000hr.	0/5
Temp. Humidity Storage	60℃, 90% RH, 1,000hr.	0/5
Steady State Operating life	25℃, 80mA, 2,000hr.	0/5
High Temperature Operating Life	85℃, 60mA, 2,000hr	0/5
Low Temperature Operating Life	-30℃, 80mA, 2,000hr.	0/5
Steady State Operating life Of High Humidity Heat	60℃, 90% RH, 80mA, 2,000hr.	0/5
Thermal Shock	-40℃(30min)→100℃(30min.), 100 cycle	0/5
ESD	HBM, 100 pF, 1.5 kohm, 3 times	0/5

10.2 Criteria for Judging the Damage

Items	Test Conditions	Criteria for judgment
Luminous Flux (ϕ_v)	$I_F = 60\text{mA}$	> 70% of S
Forward Voltage (V_F)	$I_F = 60\text{mA}$	Less than 110% of U

* U means the upper limit of specified characteristics, S means initial value.

11. Part Name Description

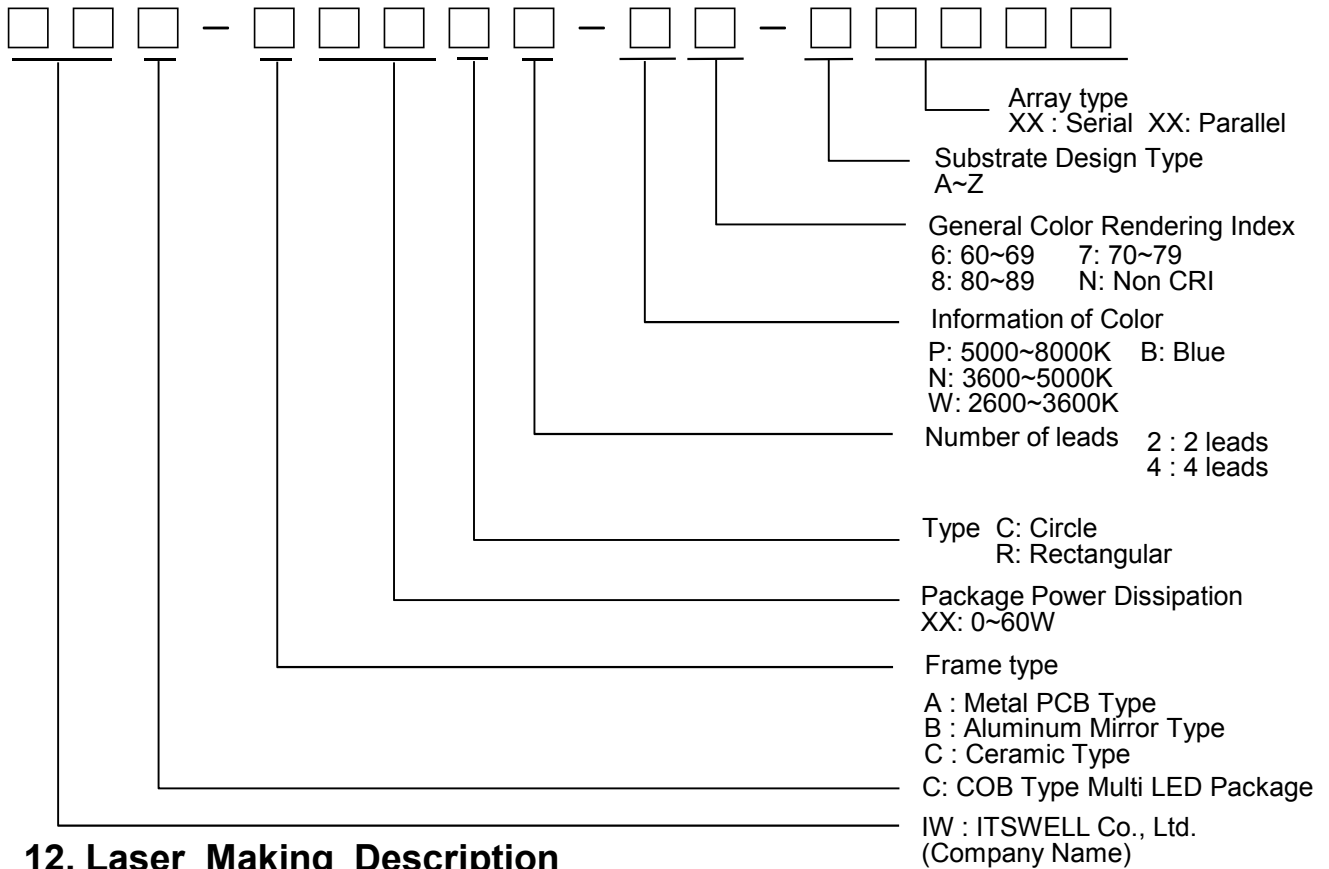

12. Laser Making Description

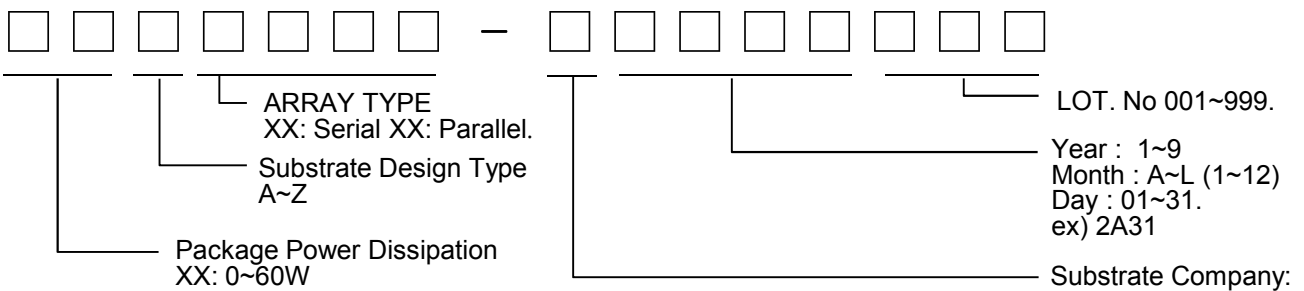

13. Attention : Electric Static Discharge (ESD) Protection



The symbol shown on the page herein to introduce 'Electro-Optical Characteristics'. ESD protection for GaP and AlGaAs is based chips is still necessary even though they are safe in low static-electric discharge. Material in AlInGaP, GaP, or/and InGaN based chips are STATIC SENSITIVE devices. ESD protection has to considered and taken in the initial design stage. If manual work/process is needed, please ensure the device is well protective from ESD during all the process.

