

SPECIFICATION

① **Product : 5mm YELLOW LAMP LED**

② **Part No : IWL-Y5R35F-TNT**

③ **Customer :**

④ **Date : 2008. 06. 10 Ver.1.1**

Customer :

Checked By	Checked By	Checked By	Checked By	Approval

Manufacturer : ITSWELL Co., LTD

Proposed By	Checked By	Checked By	Checked By	Approval
				

Comment

--



Incheon Factory
58B-4L 626-3 Gozan-dong Namdong-gu Incheon-city 405-817 KOREA
Tel: 82-31-814-1972 FAX: 82-31-822-9009
Ochang Factory & Head Office :
363-880, 9-4Block, Ochang Scientific Industrial Complex, 1115-4 Namchon-ri, Oksan-myeon, Chengwon-gun, Chungbuk 363-911 Korea
URL : www.itswell.com, TEL : int) 82-43-218-1800, FAX.: int) 82-43-218-1805

5mm YELLOW LAMP LED

IWL-Y5R35F-TNT



■ Features

- Round Type type lamp
- 5mm resin mold type
- Colored Yellow , water clear transparency lens type
- High luminous intensity
- Chip material based AlGaInP

■ Absolute Maximum Ratings(Ta=25℃)

Parameter	Symbol	Value	Unit
Power Dissipation	P _d	69	mW
Continuous Forward Current	I _F	30	mA
Peak Forward Current *1	I _{FP}	100	mA
Reverse Voltage	V _R	5	V
Operating Temperature	T _{opr}	-25 ~ 80	℃
Storage Temperature	T _{stg}	-40 ~100	℃
Soldering Temperature	T _{sol}	260 (10sec)	℃

*1 Duty ratio = 1/10, Pulse width = 0.1ms

■ Electro-optical Characteristics(Ta=25℃)

Parameter	Symbol	Condition	Min.	Typ.	Max.	Unit
Forward Voltage	V _F	I _F = 10mA	2.0		2.3	V
Reverse Current	I _R	V _R = 5V	-	-	10	μA
Luminous Intensity	I _v	I _F = 10mA				mcd
Viewing angle	2θ _{1/2}	I _F = 10mA	-	35	-	deg.
Spectrum radiation Bandwidth	Δλ	I _F = 10mA	586		594	nm

*2 Luminous Intensity is tested by a tester calibrated by CAS 140B(CIE LED_B) and has an accuracy of10%

*3 Viewing angle is the angle until 50% of brightness measured from the front part of LED.

*4 Dominant wavelength has an accuracy of ±1nm.

■ IV Rank

Rank	IV(mcd)
N	2100 - 2700
P	2700 - 3500
Q	3500 - 4500

■ VF Rank

Rank	VF(V)
a	2.0 - 2.1
b	2.1 - 2.2
c	2.2 - 2.3

■ WD Rank

Rank	VF(V)
A	586 - 588
B	588 - 590
C	590 - 592
D	592 - 594

5mm YELLOW LAMP LED

IWL-Y5R35F-TNT



Typical Curves

Forward Current vs. Forward Voltage

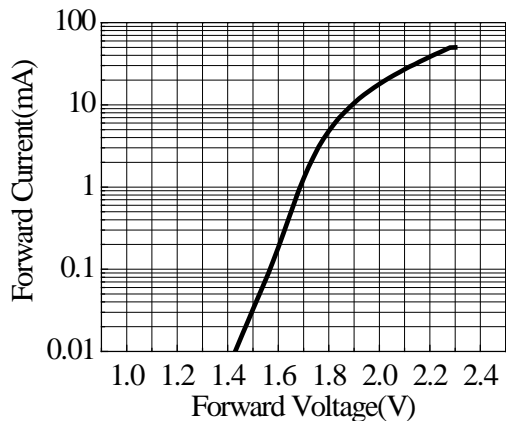

Forward Current vs. Ambient Temperature

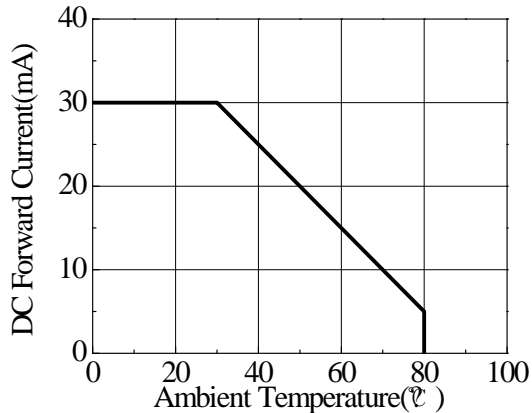

Relative Luminous Intensity vs. Ambient Temperature

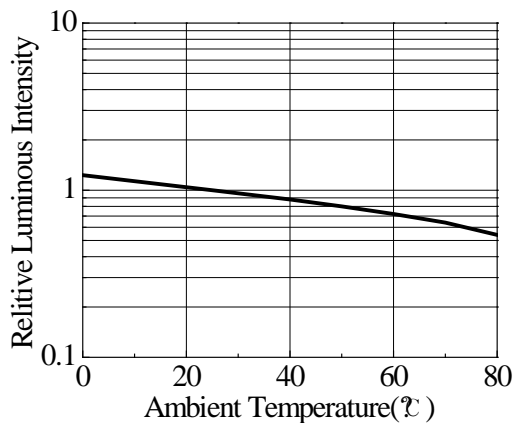

Relative Luminous Intensity vs. Forward Current

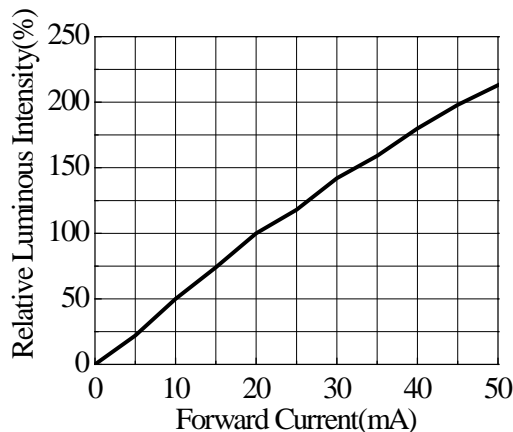

Relative Intensity vs. Wavelength

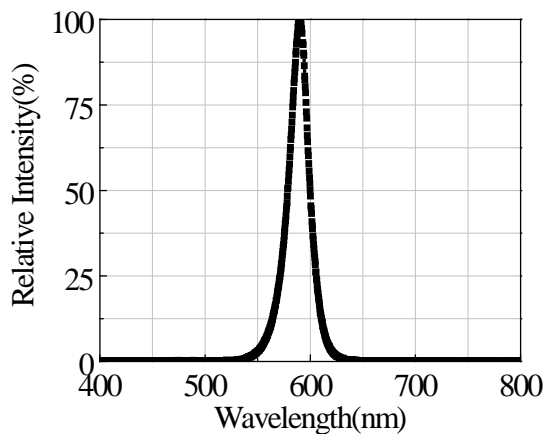

Radiation Diagram

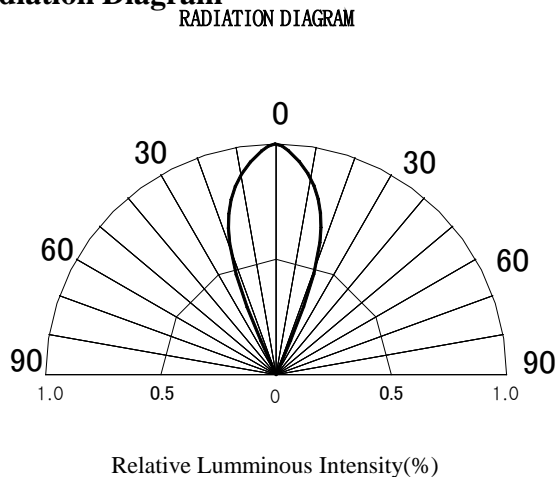

5mm YELLOW LAMP LED

IWL-Y5R35F-TNT



Out Line Dimension

- With Stopper

- Without Stopper

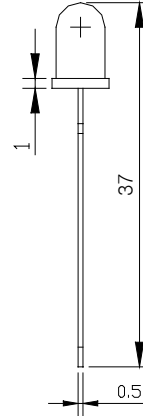
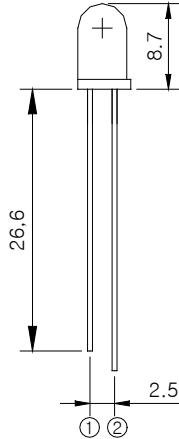
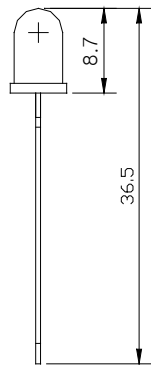
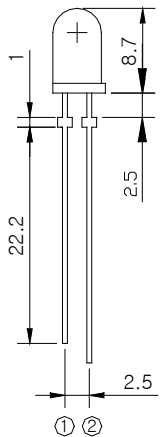
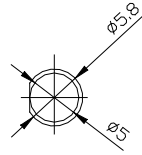
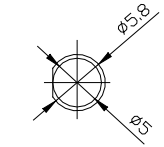

Taping Dimension & Packing

- Bulk Packing

Inner Box

Bag packing

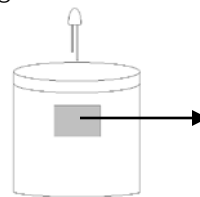

Label

ITSWELL PACKING SLIP	
Product:	
Type No:	
Q'ty:	
Lot No:	
Notice:	

Out Packing

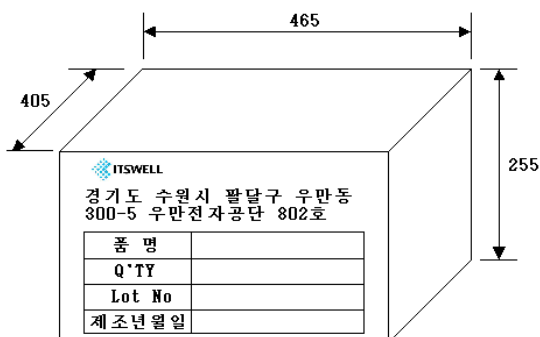

- Maximum Inner Box 20 / 1 Box
30,000 pcs/ 1 Box
- Out box material : Carton

5mm YELLOW LAMP LED IWL-Y5R35F-TNT



- Tapping Packing

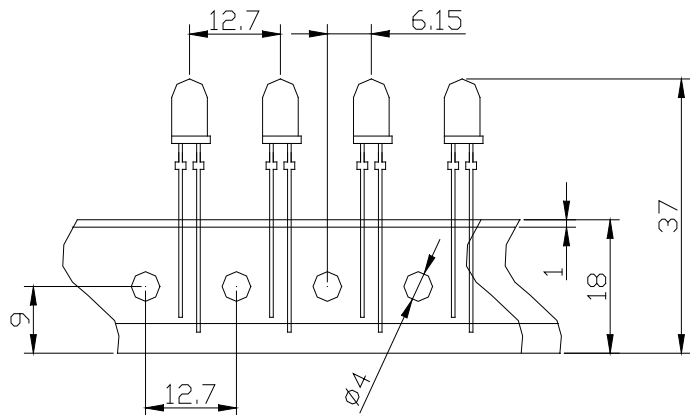

- Note :
1. Base Material : Fe Alloy
 2. Lead Plating : Ag/Ni
 3. Molding : Epoxy
 4. Pb Free

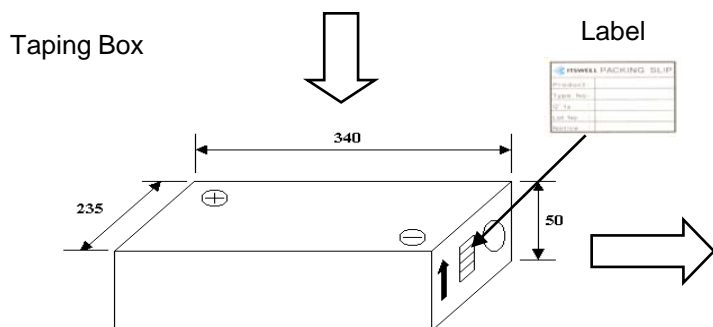

Tapping Box (Carton)
1 Tapping box / Pack with Silica gel
2,000 pcs/ 1 Tapping

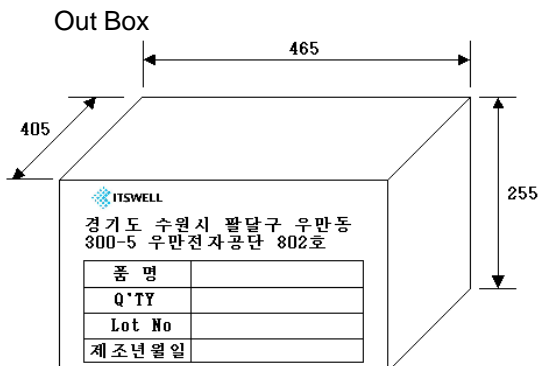

Maximum 10 tapping box / Box
20,000 pcs/ Box

■ Precaution in use

① Soldering Conditions

- When soldering Dome LED , Heat may affect the electrical and optical characteristics of the LEDs.
- In soldering, do not stress the lead frame and the resin part under the high temperature.
- The epoxy part should be protected from mechanical stress or vibration until the Dome LEDs return to room temperature after soldering.
- Preliminary heating to be at 180 °C max. for 120 Seconds max.
- Soldering heat to be at 260 °C max. for 5sec. Max.
- For manual Soldering is Not more than 3sec @MAX350 °C , under soldering iron

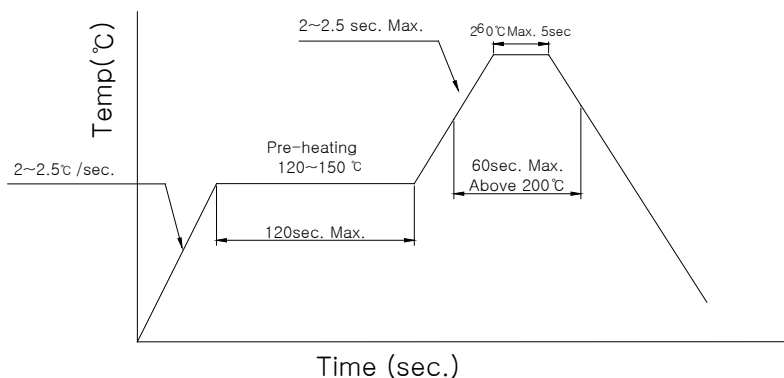

② Storage

- Use within 7 days after opening packing. Store in 10 to 30 °C. Dome LED lead frames are plated silver. The silver surface may be affected by environment which contains corrosive gases and so on. Please avoid conditions which may cause the Dome LED to corrode, tarnish or discolor.

③ Static Electricity

- Static electricity or surge voltage damages the Dome LEDs. It is recommended that a wrist band or an anti-electrostatic glove be used when handling the LEDs.
- A tip soldering iron is requested to be grounded. An ionizer should also be installed where risk of static.
- All devices, equipment and machinery must be properly grounded (via 1MΩ). It is recommended that measures be taken against surge voltage to the equipment that mounts the Dome LEDs.

④ Cleaning

- Isopropyl Alcohol or Ethylene Alcohol is recommended in 5 minutes at room temperature. Don't use unspecified chemicals; they may cause cracks or haze on the surface of the epoxy resin.
- Before cleaning, a pre-test should be done to confirm whether any damage to the Dome LED will occur.
- Freon solvents should not be used to clean the Dome LEDs because of worldwide regulations.

5mm YELLOW LAMP LED

IWL-Y5R35F-TNT



■ Reliability

- Reliability Test Item

Test Item	Standard Test Method	Test Conditions	Note	Number of Damaged
Resistance to Soldering Heat (Reflow Soldering)	JEITA ED-4701 300 301	Tsld = 260℃, 5sec. (Pretreatment 30 ℃, 70%, 168hrs)	2 times	0/50
Solderability (Reflow Soldering)	JEITA ED-4701 200 303	Tsld = 235 ± 5℃, 5sec. (Lead Solder)	1 time Over 95%	0/50
Thermal Shock	JEITA ED-4701 100 105	-40 ℃ ~ 100 ℃ 15sec 15sec	100 Cycles	0/50
Temperature Cycle	JEITA ED-4701 100 105	-40 ℃ ~ 25℃~ 100℃ ~ 25 ℃, 30min 5min 30min 5min	100 Cycles	0/50
High Temp. Storage	JEITA ED-4701 200 201	Ta = 100℃	1000hrs	0/50
Temp. Humidity Storage	JEITA ED-4701 100 103	Ta = 60 ℃, RH = 90%	1000hrs	0/50
Low Temp. Storage	JEITA ED-4701 200 202	Ta = -40 ℃	1000hrs	0/50
Steady State Operating Life Condition	-	Ta = 25 ℃, IF = 20mA	1000hrs	0/50
Steady State Operating Life of High Temp.	-	Ta = 85 ℃, IF = 5mA	1000hrs	0/50
Steady State Operating Life of High Humidity Heat	-	60 ℃, RH = 90%, IF = 15mA	500hrs	0/50
Steady State Operating Life of Low Temp.	-	Ta = -30, IF = 20mA	1000hrs	0/50

- Criteria for Judging the Damage

Items	Test Conditions	Criteria for judgment
Luminous Intensity (IV)	I _F = 10mA	> 70% of S
Forward Voltage (VF)	I _F = 10mA	Less than 120% of U

* U means the upper limit of specified characteristics, S means initial value.

5mm YELLOW LAMP LED

IWL-Y5R35F-TNT



Part Name Description

I W L - Y 5 R 35 F - T N T

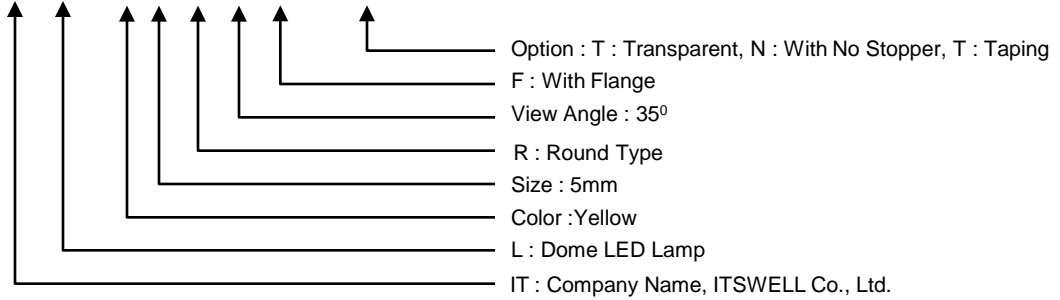

ATTENTION : Electric Static Discharge (ESD) Protection



The symbol shown on the page herein to introduce 'Electro-Optical Characteristics'. ESD protection for GaP and AlGaAs is based chips is still Necessary even though they are safe in low static-electric discharge. Material in AlInGaP, GaP, or/and InGaN based chips are static sensitive devices. ESD protection has to considered and taken in the initial design stage. If manual work/process is needed, please ensure the device is well protective From ESD during all the process.



LED's ESD Level is 'Class 2' and The range of Forward Voltage is 1999V ~ 3999V.

