

# SPECIFICATION



**Product :** IRed SMD LED (1608, 0.6t)

**Part No. :** IWS-165-ICXWF





**Customer :**

**Date :** 2008. 07. 04 Ver.3.0

**Customer :**

Checked By	Checked By	Checked By	Checked By	Approval

**Manufacturer : ITSWELL Co., LTD**

Proposed By	Checked By	Checked By	Checked By	Approval
				 2008.7.4

**Comment**

# Topview 1608 IRed LEDs

## IWS-165-ICXWF



### 1. Features

- High Luminous Intensity : Long operation life
- Low Current Application : Low power consumption
- Excellent Uniformity on Color, Intensity and Forward Current
- 100% Probing Test

### 2. Applications

- Telecommunication : Indicator and backlighting in telephone
- Flat Key Pad backlight for Mobile, switch and symbol
- Indoor sign boards
- General Use

### 3. Outline Drawing and Dimension

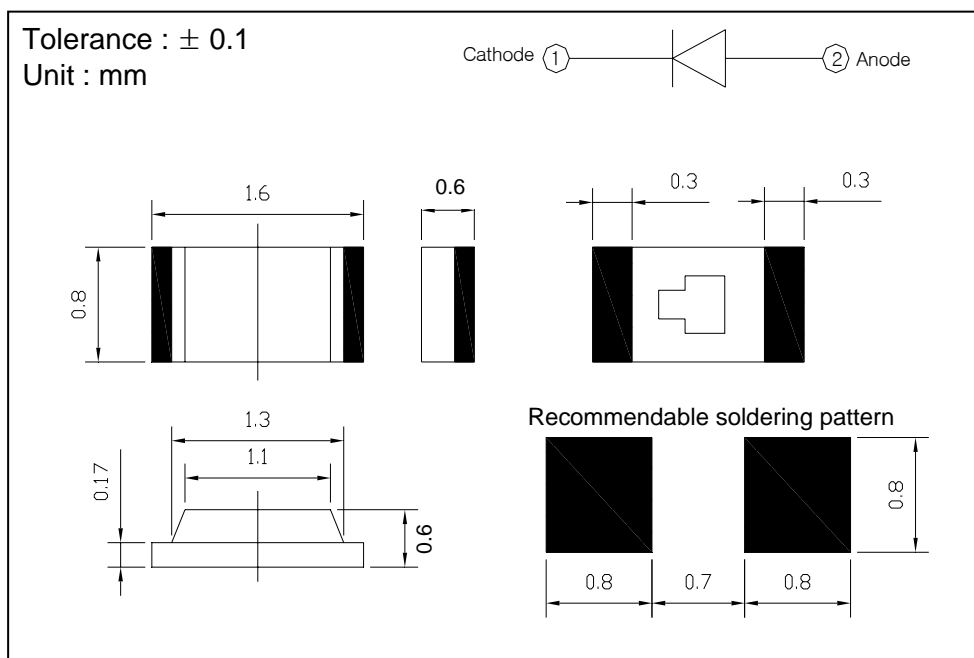

# Topview 1608 IRed LEDs

## IWS-165-ICXWF



### 4. Absolute Maximum Ratings

Items	Symbols	Ratings	Unit
Operation Forward Current	$I_F$	20	mA
Peak Pulsed Forward Current* <sup>1</sup>	$I_{PF}$	100	mA
Reverse Voltage	$V_R$	5	V
Operating Temperature Range	$T_{op}$	-30 ~ +85	°C
Storage Temperature Range	$T_S$	-40 ~ +100	°C
Soldering Temperature	$T_{SOL}$	260±5	°C

\* 1 Duty ratio = 1/10, Pulse width = 0.1ms

### 5. Electrical & Optical Characteristics (Ta : 25°C)

Parameter	Symbol	Conditions	Min.	Typ.	Max.	Unit.
Forward Voltage	$V_F$	$I_F = 20 \text{ mA}$	1.3	1.5	1.9	V
Reverse Current	$I_R$	$V_R = 5 \text{ V}$	-	-	10	uA
Power Intensity* <sup>2</sup>	$P_o$	$I_F = 20 \text{ mA}$	3	-	9	mW/sr
Peak Wavelength* <sup>3</sup>	$W_p$	$I_F = 20 \text{ mA}$	830	-	870	nm
View Angle* <sup>4</sup>	$2\Theta_{1/2}$	$I_F = 20 \text{ mA}$	-	130	-	°

• 2 Power Intensity is tested by a tester calibrated by CAS 140B(CIE LED\_B) and has an accuracy of 10%

• 3 Peak wavelength has an accuracy of ±1nm.

• 4 Viewing angle is the angle until 50% of brightness measured from the front part of LED.

#### 5.1 Power Intensity Rank

Rank	Power Intensity (mW/sr)
A	3 - 5
B	5 - 7
C	7 - 9

#### 5.3 Forward Voltage Rank

Rank	Forward Voltage (V)
a	1.3 - 1.5
b	1.5 - 1.7
c	1.7 - 1.9

#### 5.2 Peak Wavelength Rank

Rank	Peak wavelength (nm)
A	830 - 850
B	850 - 870

# Topview 1608 IRed LEDs

## IWS-165-ICXWF



### 6. Typical Characteristic Curve

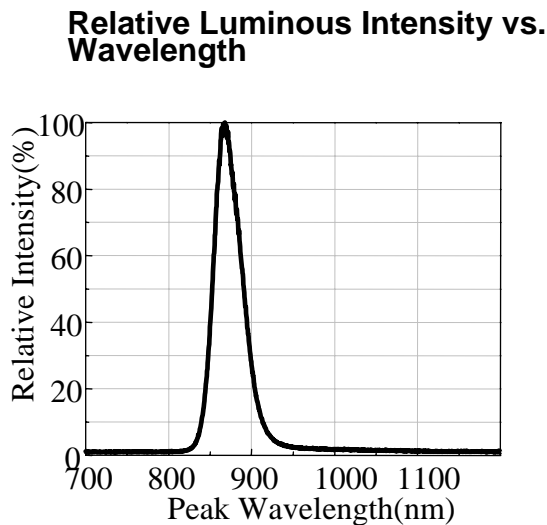
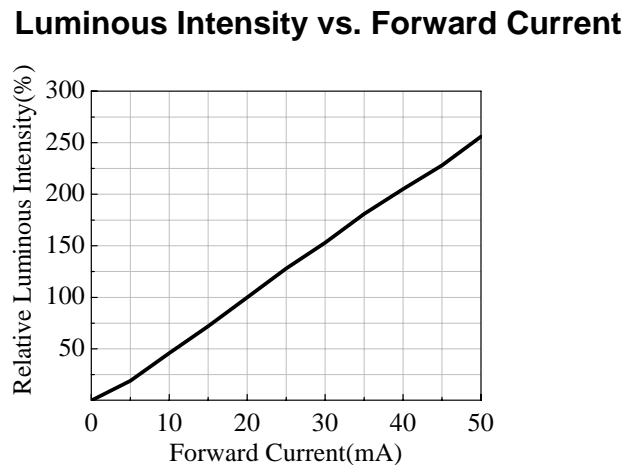
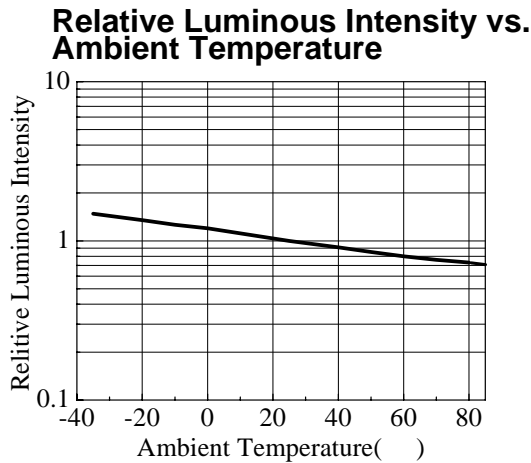
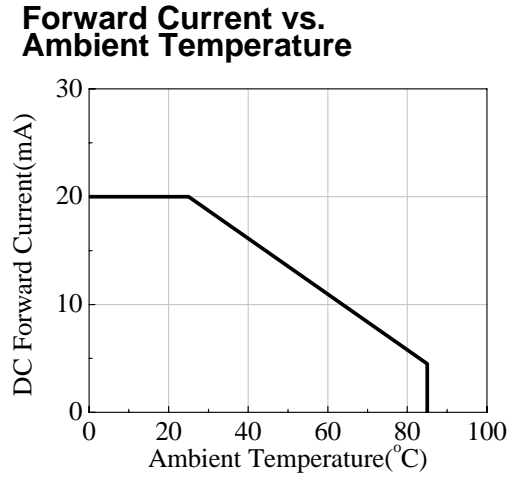
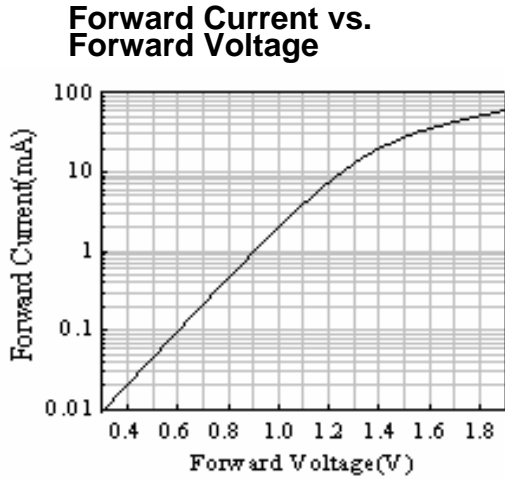

### Radiation Diagram

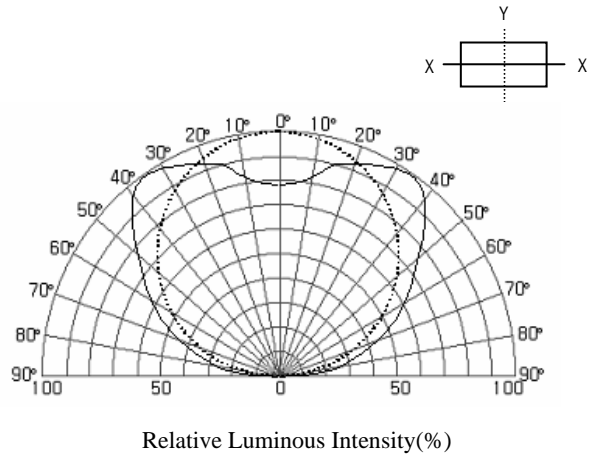

# Topview 1608 IRed LEDs

## IWS-165-ICXWF



### 7. Dimension of Tape / Reel

Unit : mm

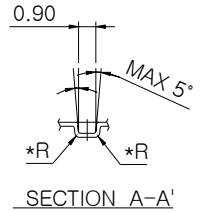
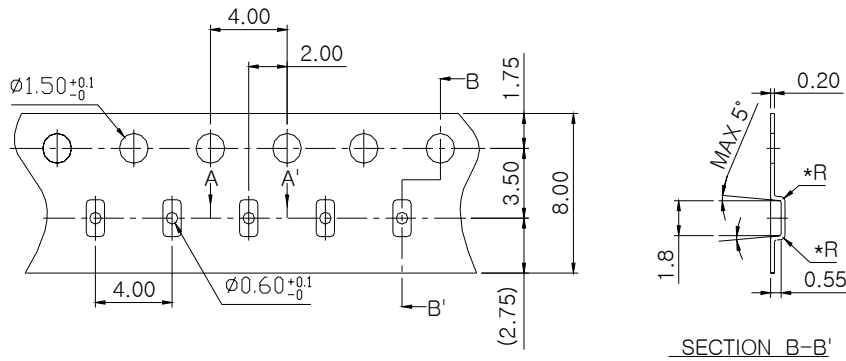

Tolerance  $\pm 0.1$  , Unit: mm

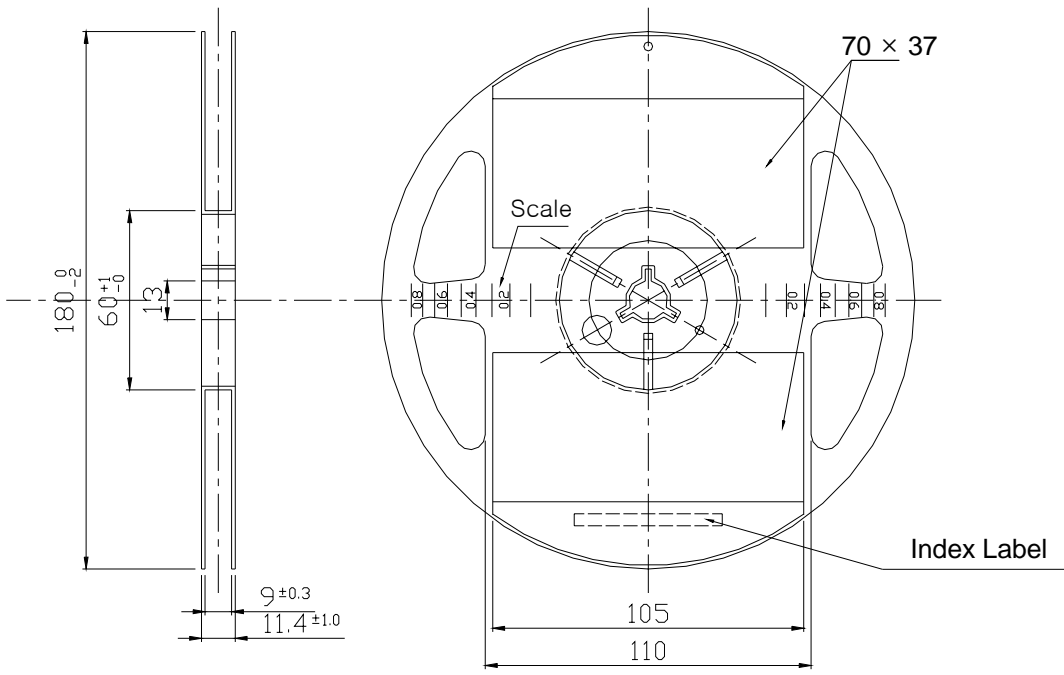

- (1) Quantity : Product are packed in one taping reel of max. 4,000 pcs.
- (2) Cumulative Tolerance : Cumulative Tolerance/10 pitches to be  $\pm 0.2$ mm
- (3) Adhesion Strength of Cover Tape : Adhesion strength to be 0.1-0.7N when the cover tape is turned off from the carrier tape at 10°C angle to be the carrier tape.
- (4) Packaging : P/N, Manufacturing data Code No. and quantity to be indicated on a damp proof Package.

# Topview 1608 IRed LEDs

## IWS-165-ICXWF



### 8. Packing Dimension

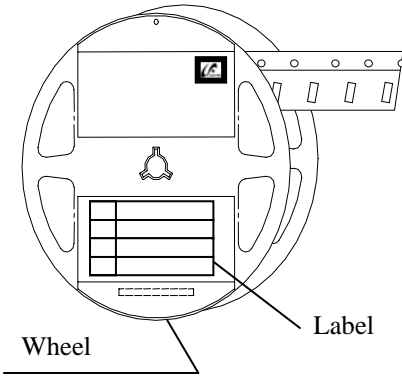

Diameter : 180 mm  
 Width : 12 mm  
 1608 ⇒ 4,000 pcs/Reel

Bake: 60°C, 4hrs

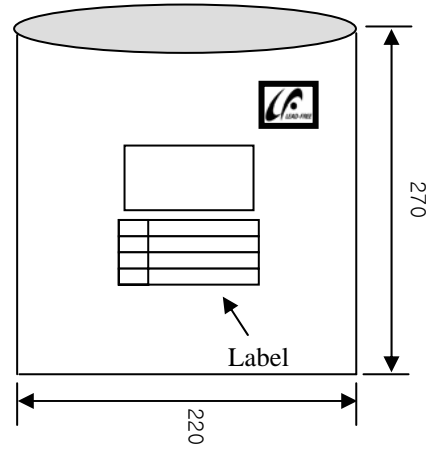

Shield Bag(Polyester/Al/LDPE)  
 1 Reel/Bag ( T = 0.1 mm ) with Silica gel



#### Al Pack & Reel Label, Box Label

(70 × 37)

<b>ITSWELL</b>		RANK #		
Lot :		IWS-165-ICXWF		
	MIN	AVG	MAX	STD
VF[volt]				
Po[mW/sr]				
WD[nm]				
Q'ty :		yyyy/mm/dd		

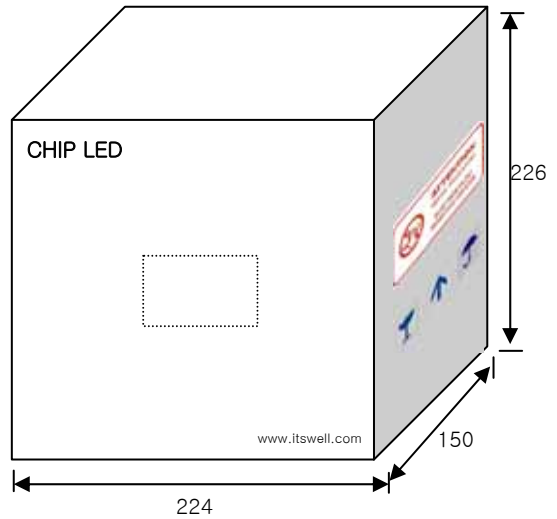

Maximum 10 Bags / 1 Inner Box  
 1608 ⇒ 40,000 pcs / 1 Inner Box

### 9. Precaution in use

#### 9.1 Soldering Conditions

- When soldering SMD LED , Heat may affect the electrical and optical characteristics of the LEDs.
- In soldering, do not stress the lead frame and the resin part under the high temperature.
- The epoxy part should be protected from mechanical stress or vibration until the SMD LEDs return to room temperature after soldering.
- Preliminary heating to be at 150 °C max. for 180 Seconds max.
- Soldering heat to be at 260 °C max. for 5 sec. Max.
- For manual Soldering is Not more than 3 sec @MAX 350 °C , under soldering iron

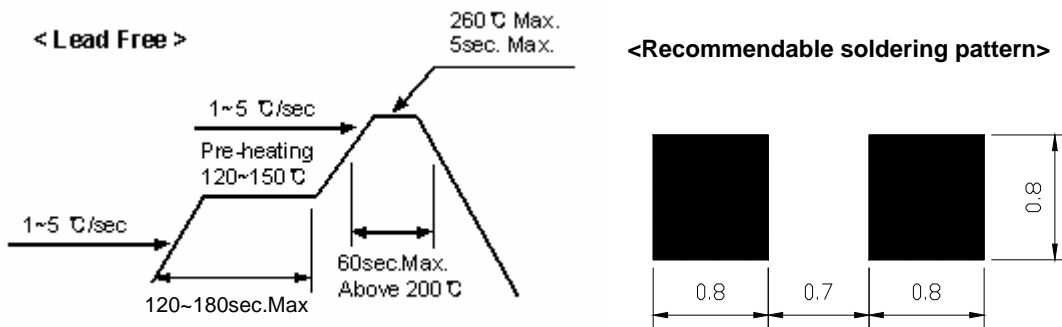

#### 9.2 Storage

- Use within 7 days after opening packing. Store in 10 to 30 °C. SMD LED lead frames are plated silver. The silver surface may be affected by environment which contains corrosive gases and so on. Please avoid conditions which may cause the SMD LED to corrode, tarnish or discolor.

#### 9.3 Static Electricity

- Static electricity or surge voltage damages the SMD LEDs. It is recommended that a wrist band or an anti-electrostatic glove be used when handling the LEDs.
- A tip soldering iron is requested to be grounded. An ionizer should also be installed where risk of static.
- All devices, equipment and machinery must be properly grounded (via 1M Ω). It is recommended that measures be taken against surge voltage to the equipment that mounts the SMD LEDs.

#### 9.4 Cleaning

- Isopropyl Alcohol or Ethylene Alcohol is recommended for 5 minutes at room temperature. Don't use unspecified chemicals as they may cause cracks or haze on the surface of the epoxy resin.
- Before cleaning, a pre-test should be done to confirm whether any damage to the SMD LED will occur.
- Freon solvents should not be used to clean the LEDs because of worldwide regulations.

### 10. Reliability

#### 10.1 Reliability Test Item

Test Items	Test Conditions	Notes
High Temperature Storage	85 °C, 500 hr.	0/32
Low Temperature Storage	-30 °C, 500 hr.	0/32
Temp. Humidity Storage	50 °C, 95 % RH, 500 hr.	0/32
Steady State Operating life	25 °C, 5 mA, 500 hr.	0/32
High Temperature Operating Life	85 °C, 5 mA, 500 hr.	0/32
Low Temperature Operating Life	-30 °C, 5 mA, 500 hr.	0/32
Steady State Operating life Of High Humidity Heat	50 °C, 95 % RH, 5 mA 500 hr.	0/32
Temperature Cycle	-40 °C (30 min.) → 25 °C (5 min.) → 100 °C (30 min.) → 25 °C (5 min.), 100 cycle	0/22
ESD	HBM, 100pF, 1.5kohm, 3 times (Contact M Forward Min 2kV, Reverse Min 200V)	0/22
Pressure Cooker Test	121 °C, 2 atm., 99.6 % RH, 48hr.	0/22

#### 10.2 Criteria for Judging the Damage

Items	Test Conditions	Criteria for judgment
Power Intensity ( mW/sr )	$I_F = 20 \text{ mA}$	More than > 70% of S
Forward Voltage ( $V_F$ )	$I_F = 20 \text{ mA}$	Less than 120% of U
Reverse Current ( $I_R$ )	$V_R = 5 \text{ V}$	Less than $10 \mu\text{A}$

\* U means the upper limit of specified characteristics, S means initial value.



# Topview 1608 IRed LEDs

## IWS-165-ICXWF



### 11. Part Name Description

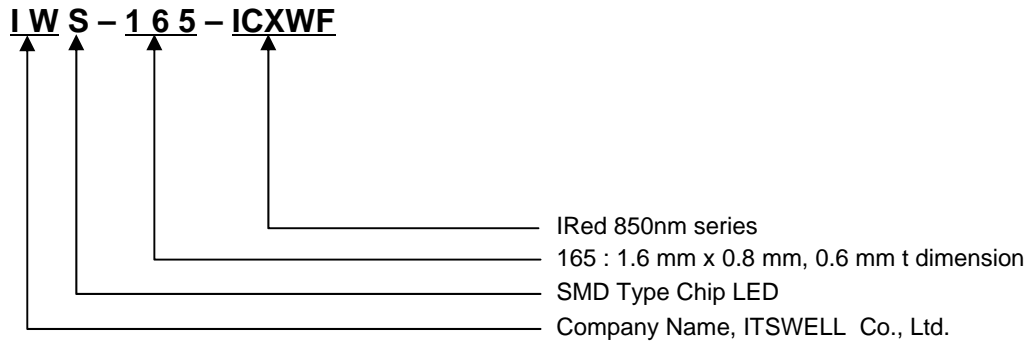

### 12. Rank Description

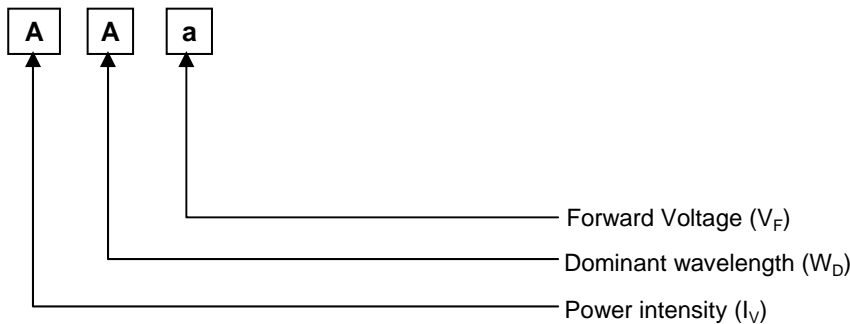

### 13. ATTENTION : Electric Static Discharge (ESD) Protection



The symbol shown on the page herein to introduce 'Electro-Optical Characteristics'. ESD protection for GaP and AlGaAs is based chips is still Necessary even though they are safe in low static-electric discharge. Material in AlInGaP, GaP, or/and InGaN based chips are STATIC SENSITIVE devices. ESD protection has to considered and taken in the initial design stage. If manual work/process is needed, please ensure the device is well protective From ESD during all the process. LED's ESD Level is 'Class II' and The range of Forward Voltage is 2000V ~ 3999V.

After opening the package, the LED's should be kept at 30%RH or less. The LEDs must be dip soldered within seven days(168 hours) after opening the moisture-proof packing. It is better not to use different rank LEDs. If use mixed rank, could not attain your object for highest quality of products.

# Topview 1608 IRed LEDs

## IWS-165-ICXWF



### Spec. Review History

<b>Review Ver.</b>	<b>Date</b>	<b>Correction List</b>	<b>Etc.</b>
Ver 1.0	2007. 10. 25	Establish	
Ver 2.0	2007. 11. 13	Po Spec 조정	
Ver 3.0	2008. 07. 04	포장 사양서 변경	