

SPECIFICATION

Product : Topview 5050 White SMD LED

Part No. : IWS-L5056-CW-K3

Date : 2010. 04. 19 Ver. 2.0

Proposed By	Checked By	Checked By	Checked By	Approval

Comment



ITSWELL Co., Ltd
58B-4L, 626-3 Gojan-dong, Namdong-gu, Incheon 405-817 KOREA
TEL:+82-32-813-1801, FAX:+82+32-816-1900
URL: <http://www.itswell.com>,

Topview 5050 SMD LED

IWS-L5056-CW-K3

1. Features

- 3 Chip High-Luminosity SMD LED
- 5.4 x 5.0 x 1.6 mm (L x W x H), 6-Pin, Small Size Surface Mount Type
- Wide Viewing Angle
- Long Operating Life

2. Applications

- Automotive: Backlight in Dashboard and Switch
- Lighting Device: Indicator, General Lighting
- Camera Flash, Hand Carrier Flash
- General Use

3. Outline Drawing and Dimension

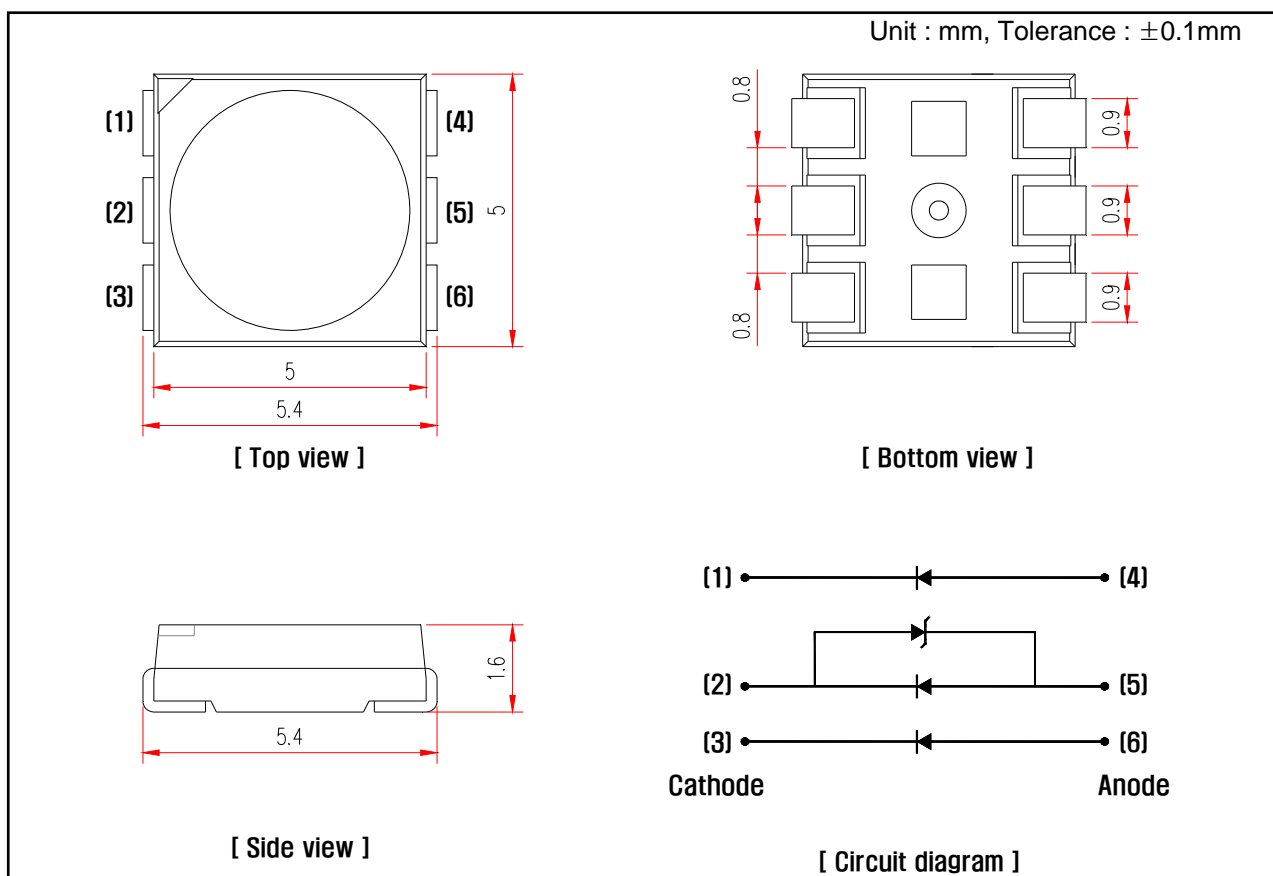

Note

1. All dimensions are in millimeters
2. All dimensions without tolerances are for reference only

4. Absolute Maximum Ratings($T_a = 25\text{ }^\circ\text{C}$)

Parameter	Symbol	Value	Unit
Power Dissipation	P_d	324	mW
Continuous Forward Current	I_F	90	mA
Peak Forward Current ^{※1}	I_{FP}	300	mA
Operating Temperature	T_{opr}	-30 ~ 85	$^\circ\text{C}$
Storage Temperature	T_{stg}	-40 ~100	$^\circ\text{C}$
Soldering Temperature	T_{sol}	260 (5sec)	$^\circ\text{C}$

※1 Duty ratio = 1/10, Pulse width = 0.1ms

5. Electro-optical Characteristics($T_a = 25\text{ }^\circ\text{C}$)

Parameter	Symbol	Conditions	Min.	Typ.	Max.	Unit.
Forward Voltage	V_F	$I_F = 60\text{ mA}$	2.8	3.2	3.6	V
Reverse Voltage	V_R	$I_R = 5\text{ mA}$	0.7	0.8	1.5	V
Luminous Intensity ^{※2}	I_v	$I_F = 60\text{ mA}$	4,000	-	8,000	mcd
Color Coordinates ^{※3}	CIE x CIE y	$I_F = 60\text{ mA}$	Refer to Color Coordinates Rank			
Viewing Angle ^{※4}	$2\theta_{1/2}$	$I_F = 60\text{ mA}$	-	120	-	$^\circ$

※2 Luminous Intensity is tested by a tester calibrated by CAS 140B(CIE LED_B) and has an accuracy of 10%

※3 Color Coordinates has an accuracy of ± 0.01 .

※4 Viewing Angle is the angle until 50% of brightness measured from the front part of LED.

5.1 Luminous Intensity Rank

Rank	Luminous Intensity (mcd)
C	4000 ~ 5000
D	5000 ~ 6000
E	6000 ~ 7000
F	7000 ~ 8000

5.2 Forward Voltage Rank

Rank	Forward Voltage (V)
0	2.8 ~ 3.0
2	3.0 ~ 3.2
4	3.2 ~ 3.4
6	3.4 ~ 3.6

5.3 Color Coordinates Rank ($I_F = 60 \text{ mA}$, $T_a = 25 \text{ }^\circ\text{C}$)

BW				CW							
Z1		Z2		A1		A2		B1		B2	
x	y	x	y	x	y	x	y	x	y	x	y
0.2400	0.2000	0.2500	0.2100	0.2600	0.2200	0.2700	0.2300	0.2800	0.2400	0.2900	0.2500
0.2400	0.2600	0.2500	0.2700	0.2600	0.2800	0.2700	0.2900	0.2800	0.3000	0.2900	0.3100
0.2500	0.2700	0.2600	0.2800	0.2700	0.2900	0.2800	0.3000	0.2900	0.3100	0.3000	0.3200
0.2500	0.2100	0.2600	0.2200	0.2700	0.2300	0.2800	0.2400	0.2900	0.2500	0.3000	0.2600

PW													
7500K		7040K-4746K				6500K				5700K			
8145-7040K		7040K-6020K		6020K-5331K		5331K-4746K		7040K-6530K		6530K-6020K		6020K-5665K	
Y		V1		V2		V3		Z		A		B	
x	y	x	y	x	y	x	y	x	y	x	y	x	y
0.3057	0.2671	0.3125	0.2842	0.3243	0.2951	0.3353	0.3053	0.3089	0.3012	0.3152	0.3070	0.3229	0.3142
0.2891	0.3175	0.3089	0.3012	0.3229	0.3142	0.3362	0.3259	0.3008	0.3399	0.3095	0.3484	0.3198	0.3585
0.3025	0.3321	0.3229	0.3142	0.3362	0.3259	0.3500	0.3371	0.3095	0.3484	0.3198	0.3585	0.3282	0.3652
0.3140	0.2770	0.3243	0.2951	0.3353	0.3053	0.3472	0.3164	0.3152	0.3070	0.3229	0.3142	0.3292	0.3200

PW						NW							
5700K		5000K				4500K							
5665K-5311K		5311K-5028K		5028K-4746K		4746K-4503K		4503K-4260K		4260K-3985K		3985K-3710K	
C		L		M		D		E		F		G	
x	y	x	y	x	y	x	y	x	y	x	y	x	y
0.3292	0.3200	0.3362	0.3259	0.3429	0.3317	0.3500	0.3371	0.3574	0.3428	0.3648	0.3479	0.3755	0.3550
0.3282	0.3652	0.3381	0.3732	0.3465	0.3797	0.3562	0.3843	0.3650	0.3899	0.3756	0.3966	0.3882	0.4044
0.3381	0.3732	0.3465	0.3797	0.3567	0.3881	0.3650	0.3899	0.3756	0.3966	0.3882	0.4044	0.4035	0.4134
0.3362	0.3259	0.3429	0.3317	0.3500	0.3371	0.3574	0.3428	0.3648	0.3479	0.3755	0.3550	0.3865	0.3617

WW											
3500K				3000K				2700K			
3710K-3465K		3465K-3220K		3220K-3045K		3045K-2870K		2870K-2670K		2670K-2500K	
J		K		P		Q		R		S	
x	y	x	y	x	y	x	y	x	y	x	y
0.3865	0.3617	0.3988	0.3684	0.4117	0.3745	0.4221	0.3790	0.4599	0.4329	0.4767	0.4360
0.4022	0.4094	0.4165	0.4169	0.4332	0.4241	0.4456	0.4287	0.4767	0.4360	0.4921	0.4374
0.4165	0.4169	0.4332	0.4241	0.4456	0.4287	0.4599	0.4329	0.4486	0.3875	0.4621	0.3902
0.3988	0.3684	0.4117	0.3745	0.4221	0.3790	0.4344	0.3833	0.4344	0.3833	0.4486	0.3875

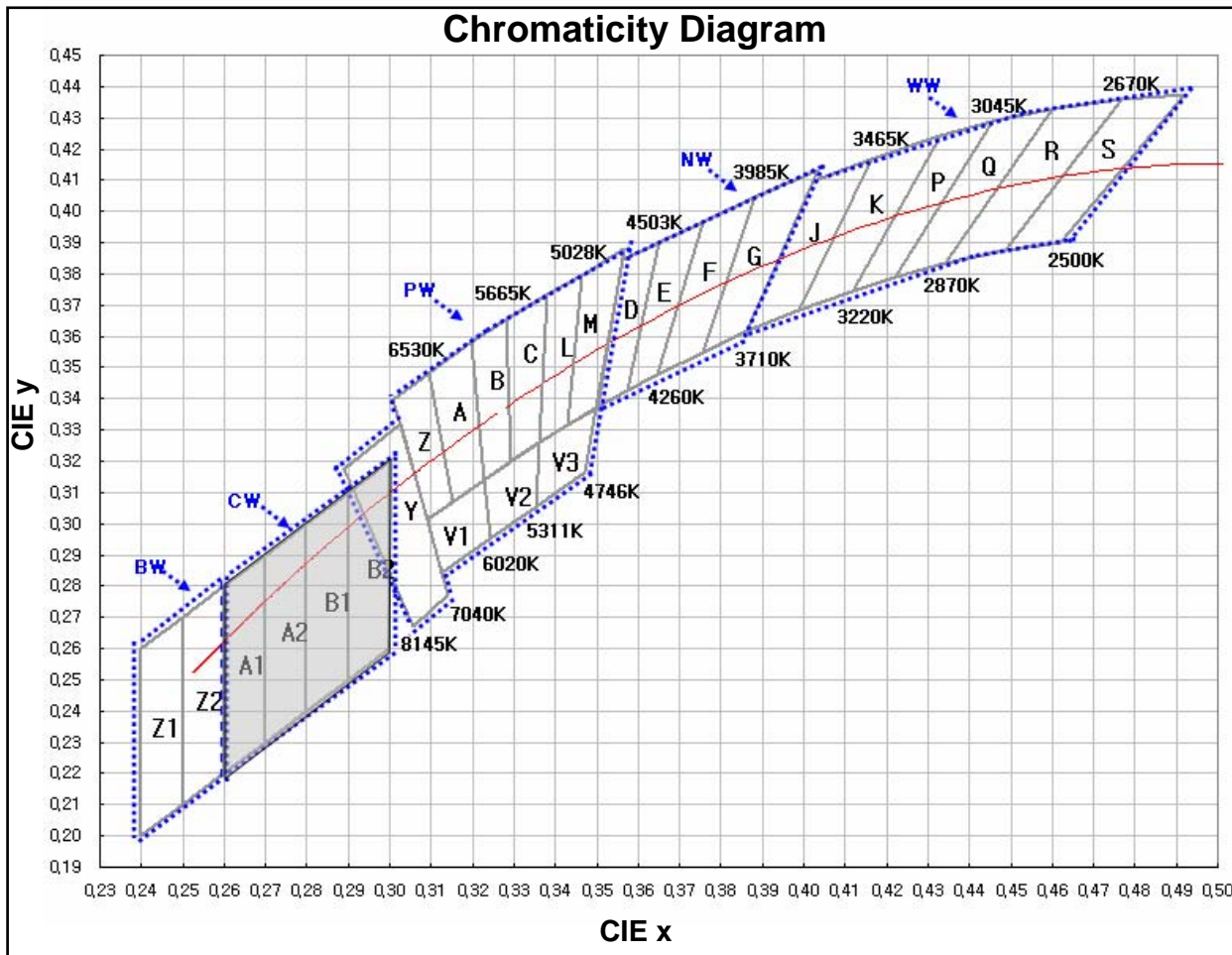

6. Typical Characteristics Curves

Forward Current vs. Forward Voltage

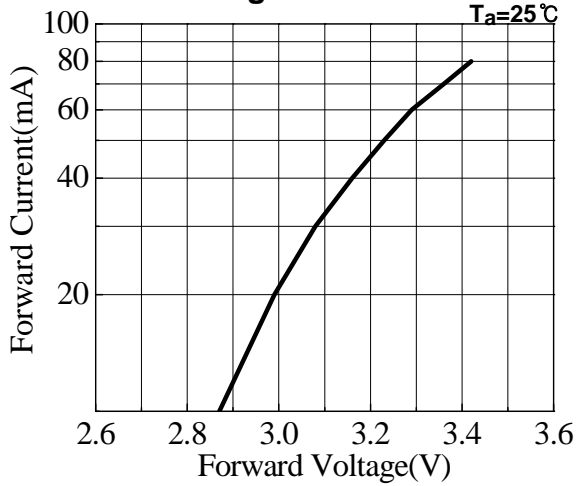

Forward Current vs. Ambient Temperature

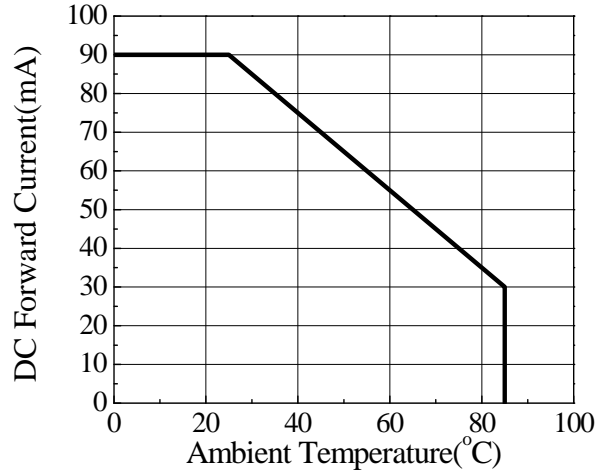

Relative Luminous Intensity vs. Ambient Temperature

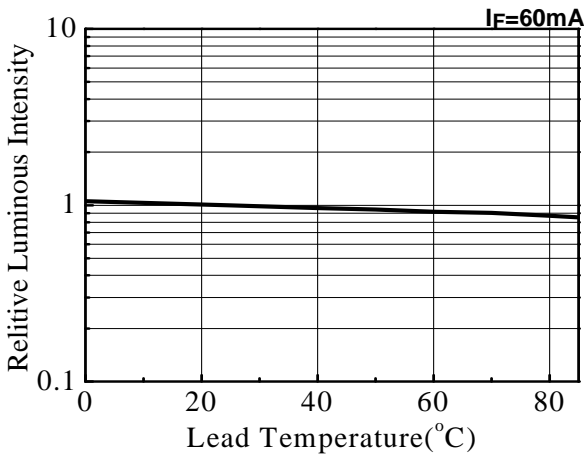

Relative Luminous Intensity vs. Forward Current

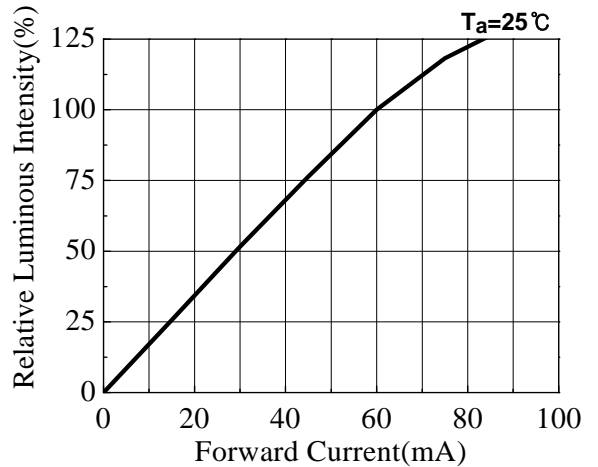

Relative Intensity vs. Wavelength

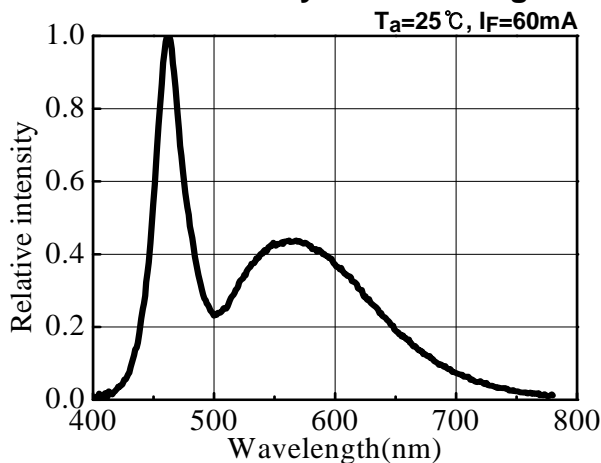

Radiation Diagram

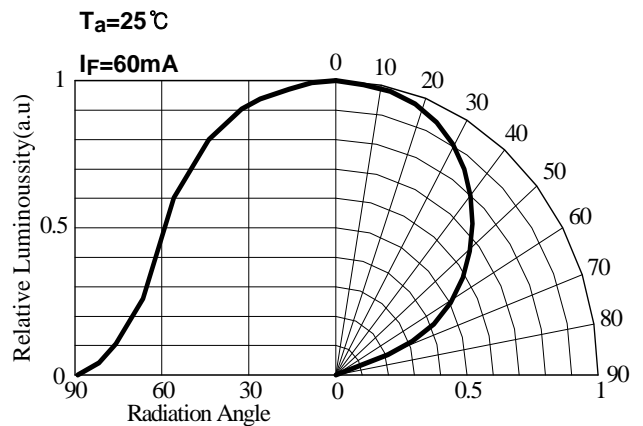

7. Dimension of Tape / Reel

7.1 Tape Dimension

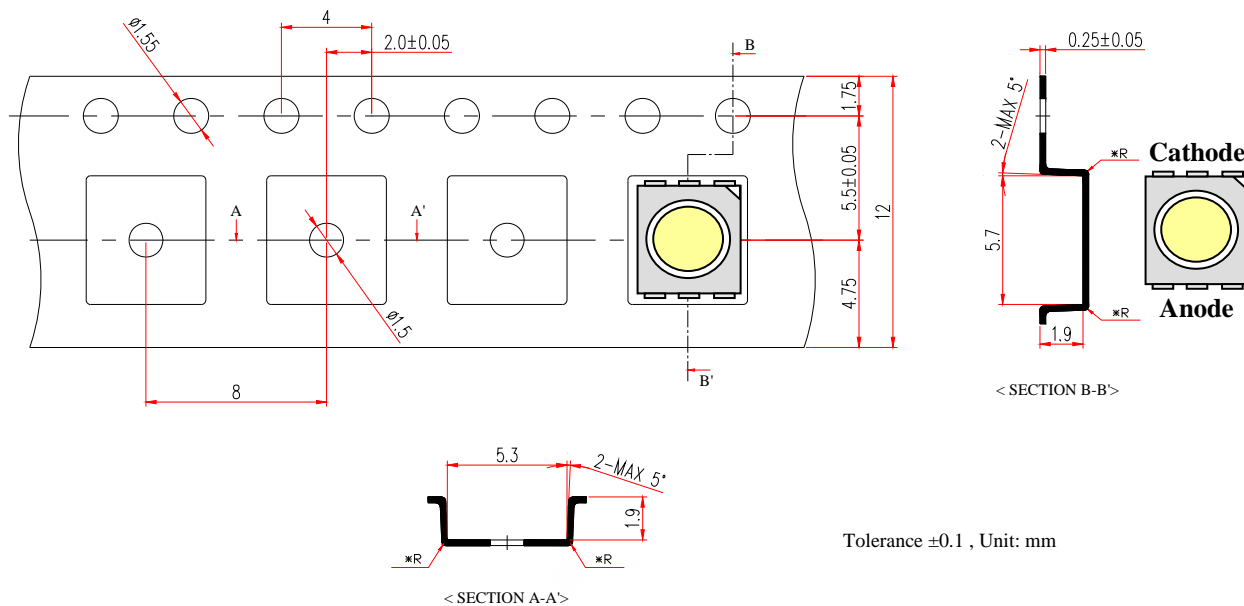

7.2 Reel Dimension

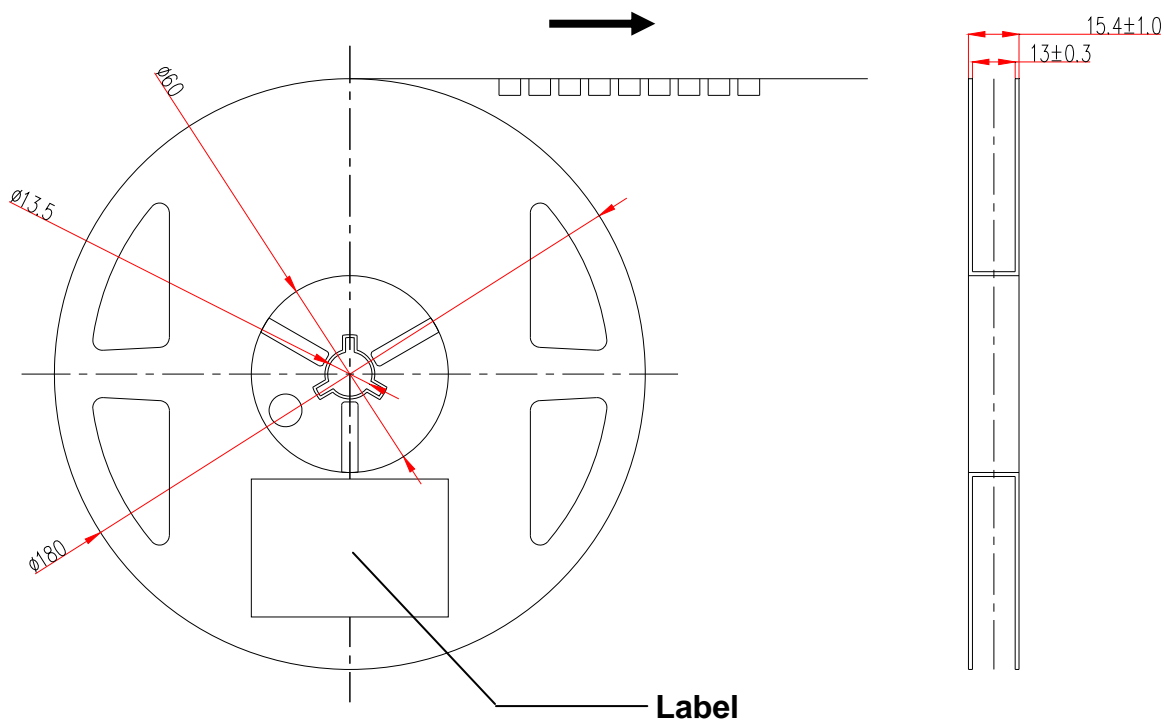

8. Packing Dimension

Unit :mm

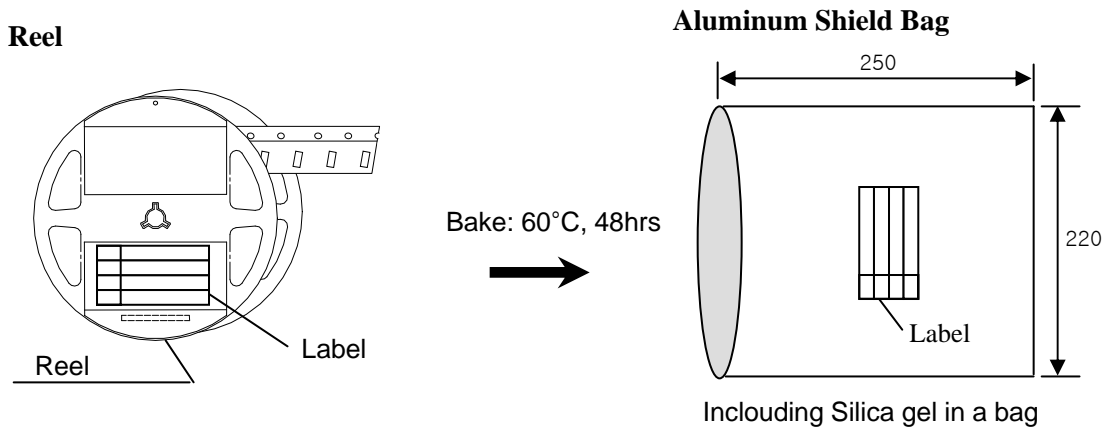

Al Pack Label, Reel Label (70 × 37)

ITSWELL				
Lot :	IWS-L5056-CW-K3			
	MIN	AVG	MAX	STD
V _f [volt]				
I _v [mcd]				
CCT[K]				
Q'ty :	yyyy/mm/dd			

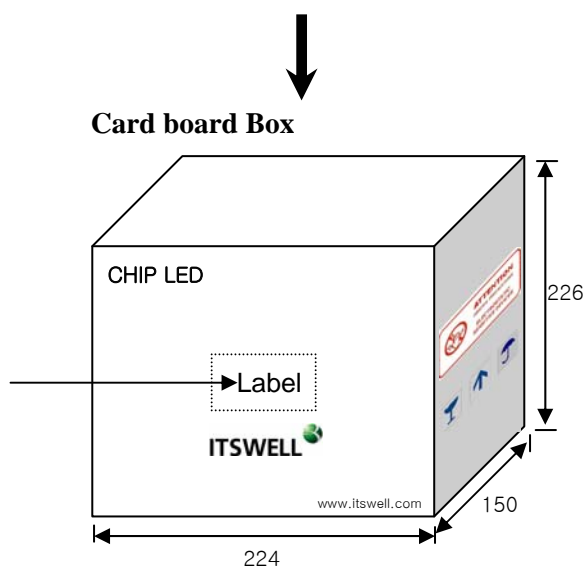

	Dimensions (mm)	Reel / Box	Q'ty / Box(pcs)
Reel	Φ180mm, 15mm Width	–	1,000 Max
Al Shield Bag	250x220	–	1,000 Max
Card board Box	224x150x226	9 Max	9,000 Max

9. Precaution in use

9.1 Soldering Conditions

- When soldering Power SMD, Heat may affect the electrical and optical characteristics of the LEDs.
- In soldering, do not stress the lead frame and the resin part under the high temperature.
- The silicone part should be protected from mechanical stress or vibration until the Power SMD return to room temperature after soldering.
- Preliminary heating to be at 160 °C max. for 120 Seconds max.
- Soldering heat to be at 260 °C max. for 5 sec. Max.
- For manual Soldering is Not more than 3 sec @MAX 350 °C, under soldering iron

< Lead Free >

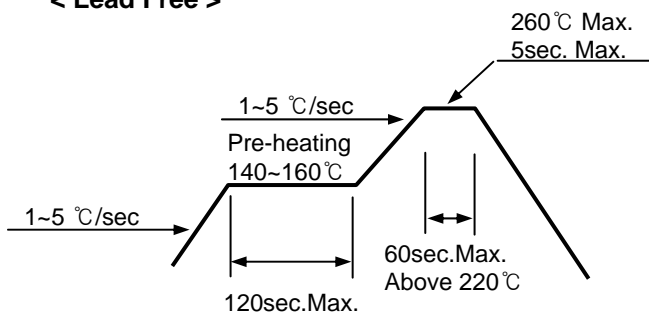

<Recommendable soldering pattern>

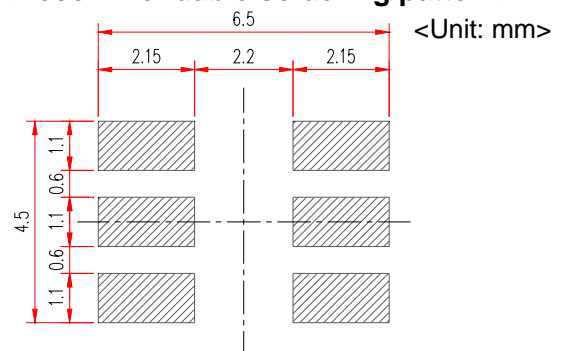

9.2 Storage

- Before opening the package, the LEDs should be kept at 30 °C or less and 70%RH or less.
- The LEDs should be used within a year.
- After opening the package, the LEDs should be kept at 30 °C or less and 30%RH or less.
- The LEDs should be used within 168 hours (7 day) after opening the package.
- If the moisture absorbent material (silicagel) has faded away or the LED have exceeded the storage time, baking treatment should be performed using the following conditions.
Baking treatment: 60 °C ±5 for 72 hours.

9.3 Static Electricity

- Static electricity or surge voltage damages the Power SMD . It is recommended that a wrist band or an anti-electrostatic glove be used when handling the LEDs.
- A tip soldering iron is requested to be grounded. An ionizer should also be installed where risk of static.
- All devices, equipment and machinery must be properly grounded (via 1MΩ). It is recommended that measures be taken against surge voltage to the equipment that mounts the Power SMD.

9.4 Cleaning

- Isopropyl Alcohol or Ethylene Alcohol is recommended in 5 minutes at room temperature.
Don't use unspecified chemical may cause crack or haze on the surface of the epoxy resin.
- Before cleaning, a pre-test should be done to confirm whether any damage to the LED will occur.
- Freon solvents should not be used to clean the LEDs because of worldwide regulations.

9.5 Heat Generation

- When the LEDs are illuminating, operating current should be decided after being considering the ambient maximum temperature.
- Please consider the heat generation of the LED when it is designed the PCB.

10. Reliability

10.1 Reliability Test Item

Test Items	Test Conditions	Notes
High Temperature Storage	100°C, 1,000hr.	0/25
Low Temperature Storage	-40°C, 1,000hr.	0/25
Temp. Humidity Storage	60°C, 90% RH, 1,000hr.	0/25
Steady State Operating life	25°C, 72mA, 1,000hr.	0/25
High Temperature Operating Life	85°C, 30mA, 1,000hr	0/25
Low Temperature Operating Life	-30°C, 60mA, 1,000hr.	0/25
Steady State Operating life Of High Humidity Heat	60°C, 90% RH, 45mA, 1,000hr.	0/25
Thermal Shock	-40°C (30min)↔100°C (30min.), 100 cycle	0/20
ESD	HBM, 100 pF, 1.5 kohm, 3 times	0/20

10.2 Criteria for Judging the Damage

Parameters	Test Conditions	Criteria for judgment
Forward Voltage (V_F)	$I_F = 60 \text{ mA}$	Less than 110% of U
Luminous Intensity (I_V)	$I_F = 60 \text{ mA}$	> 70% of S

* U means the upper limit of specified characteristics, S means initial value.

11. Part Name Description

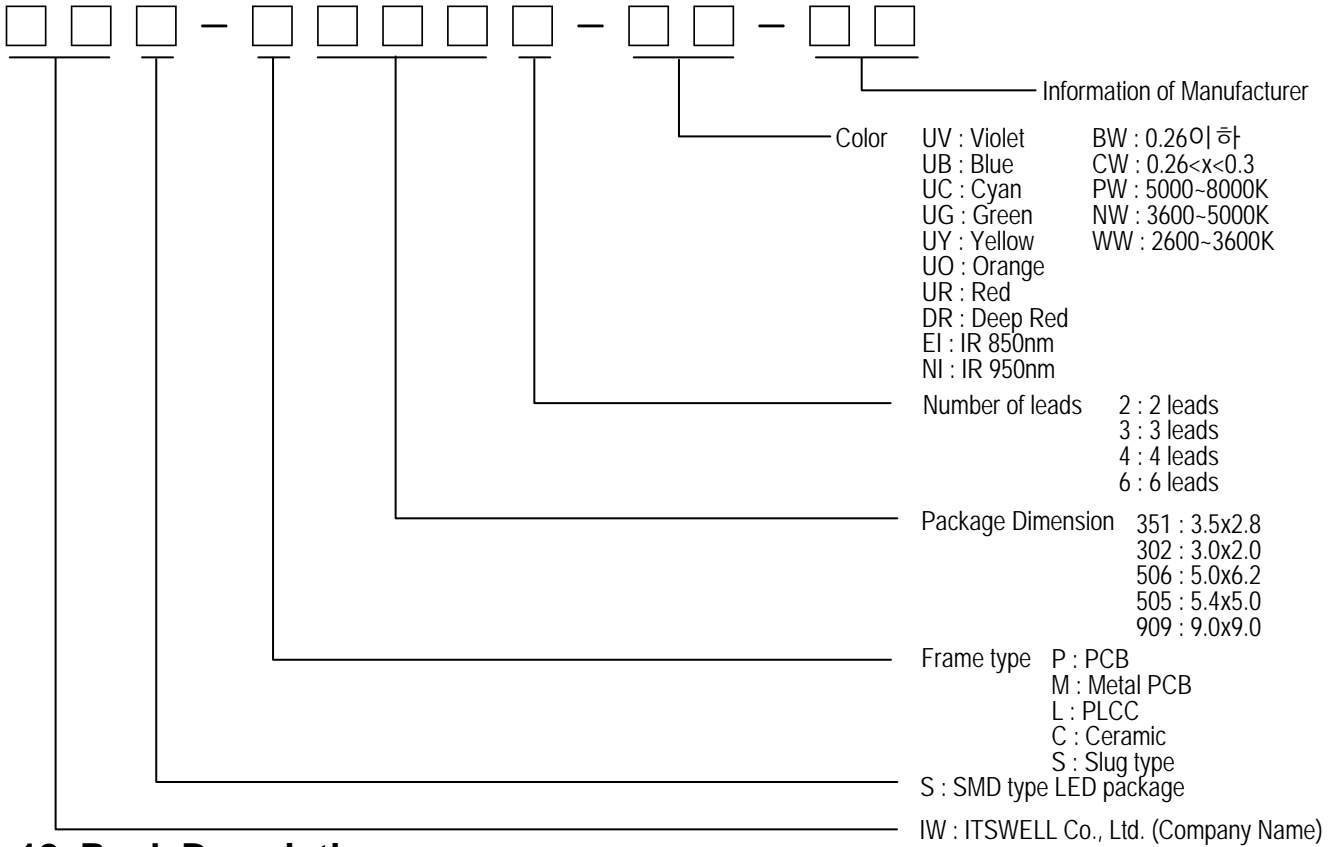

12. Rank Description

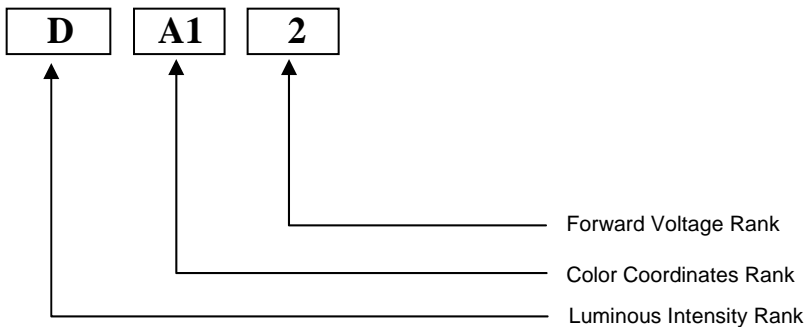

13. Attention : Electric Static Discharge (ESD) Protection



The symbol shown on the page herein to introduce 'Electro-Optical Characteristics'. ESD protection for GaP and AlGaAs based chips is still Necessary even though they are safe in low static-electric discharge. Material in AlInGaP, GaP, or/and InGaN based chips are STATIC SENSITIVE devices. ESD protection has to considered and taken in the initial design stage. If manual work/process is needed, please ensure the device is well protective From ESD during all the process.

