

# SPECIFICATION

Product : Topview 5050 RGB SMD LED

Part No. : IWS-L5056-RGB-K3

Date : 2011. 02. 28 Ver. 3.0

Proposed By	Checked By	Checked By	Checked By	Approval
결 재 완 료				

**Comment**

ITSWELL 

ITSWELL Co., Ltd  
58B-4L, 626-3 Gojan-dong, Namdong-gu, Incheon 405-817 KOREA  
TEL:+82-32-813-1801, FAX:+82+32-816-1900  
URL: <http://www.itswell.com>

# Topview 5050 SMD LED

## IWS-L5056-RGB-K3



### 1. Features

- 3 Chip High-Luminosity SMD LED
- 5.4 x 5.0 x 1.6 mm (L x W x H), 6-Pin, Small Size Surface Mount Type
- Wide Viewing Angle
- Long Operating Life

### 2. Applications

- Automotive: Backlight in Dashboard and Switch
- Lighting Device: Indicator, General Lighting
- Camera Flash, Hand Carrier Flash
- General Use

### 3. Outline Drawing and Dimension

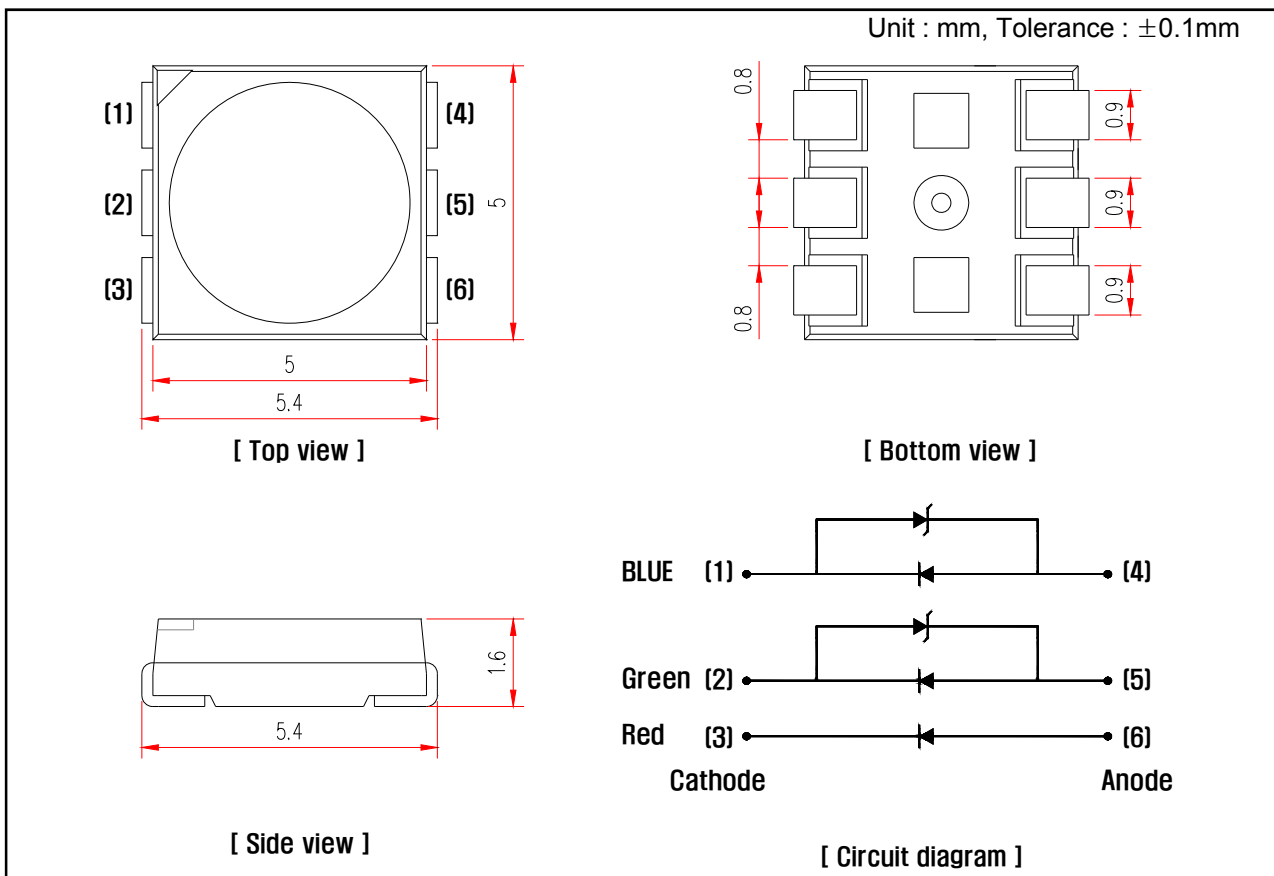

**Note**

1. All dimensions are in millimeters
2. All dimensions without tolerances are for reference only

# Topview 5050 SMD LED

## IWS-L5056-RGB-K3



### 4. Absolute Maximum Ratings( $T_a = 25\text{ }^\circ\text{C}$ )

Parameter	Symbol	Value			Unit
		Red	Green	Blue	
Power Dissipation	$P_d$	78	108	108	mW
Continuous Forward Current	$I_F$	30	30	30	mA
Peak Forward Current <sup>*1</sup>	$I_{FP}$	100	100	100	mA
Operating Temperature	$T_{opr}$	-30 ~ 85			$^\circ\text{C}$
Storage Temperature	$T_{stg}$	-40 ~ 100			$^\circ\text{C}$
Soldering Temperature	$T_{sol}$	260 (5sec)			$^\circ\text{C}$

\*1 Duty ratio = 1/10, Pulse width = 0.1ms

### 5. Electro-optical Characteristics( $T_a = 25\text{ }^\circ\text{C}$ )

Parameter	Symbol	Conditions	Min.	Typ.	Max.	Unit.	
Forward Voltage*2	$V_F$	$I_F = 20\text{mA}$	Red	1.8	2.2	2.6	V
			Green	2.8	3.3	3.6	V
			Blue	3.0	3.3	3.6	V
Reverse Current	$I_R$	$V_R = 5\text{V}$	Red	-	-	10	$\mu\text{A}$
Reverse Voltage	$V_{ZR}$	$I_R = 5\text{mA}$	Green	0.7	-	1.5	V
			Blue	0.7	-	1.5	V
Dominant Wavelength*3	$W_D$	$I_F = 20\text{mA}$	Red	618	-	635	nm
			Green	520	-	535	nm
			Blue	455	-	475	nm
Luminous Intensity*4	$I_v$	$I_F = 20\text{mA}$	Red	-	400	1000	mcd
			Green	-	900	1800	mcd
			Blue	-	200	400	mcd
Viewing angle*5	$2\theta_{1/2}$	$I_F = 20\text{mA}$	-	-	120	-	deg

\*2 Forward Voltage has an accuracy of  $\pm 0.1\text{V}$

\*3 Luminous Intensity is tested by a tester calibrated by CAS 140B(CIE LED\_B) and has an accuracy of 10%

\*4 Dominant Wavelength has an accuracy of  $\pm 2\text{nm}$

\*5 Viewing Angle is the angle until 50% of brightness measured from the front part of LED.

**5.1 Luminous intensity Rank( mcd, I<sub>F</sub> = 20mA )**

RANK	RED	GREEN	BLUE
J			200 – 300
K			300 – 400
L	400 – 600		
M	600 – 800		
N	800 – 1000		
P		900 – 1200	
Q		1200 – 1500	
R		1500 – 1800	

**5.2 Dominant Wavelength Combination Rank( nm, I<sub>F</sub> = 20mA )**

RANK	RED	GREEN	BLUE
A	618 – 635	520 – 535	455 – 475

**5.3 Forward Voltage Rank ( V, I<sub>F</sub> = 20mA )**

RANK	RED	GREEN	BLUE
D		2.8 – 3.0	
A	1.8 – 2.2	3.0 – 3.2	3.0 – 3.2
B	2.2 – 2.6	3.2 – 3.4	3.2 – 3.4
C		3.4 – 3.6	3.4 – 3.6

### 6. Typical Characteristics Curves

#### 6.1 Red

**Forward Current vs. Forward Voltage**

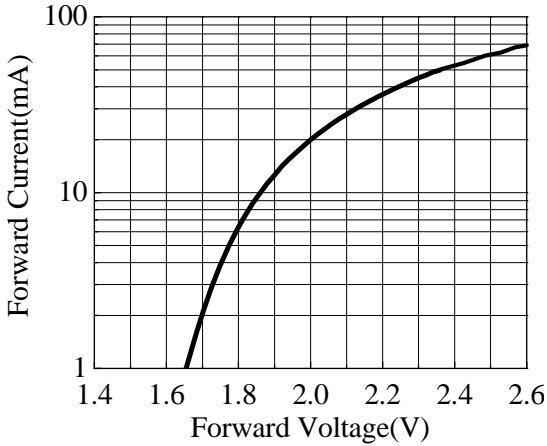

**Forward Current vs. Ambient Temperature**

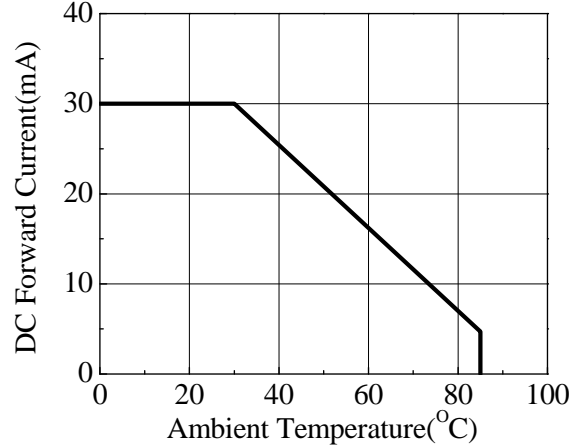

**Relative Luminous Intensity vs. Ambient Temperature**

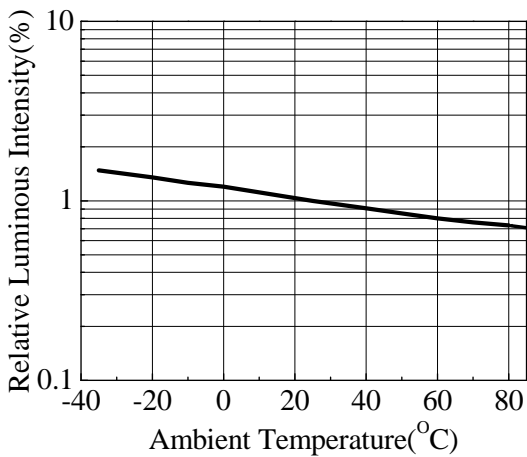

**Relative Luminous Intensity vs. Forward Current**

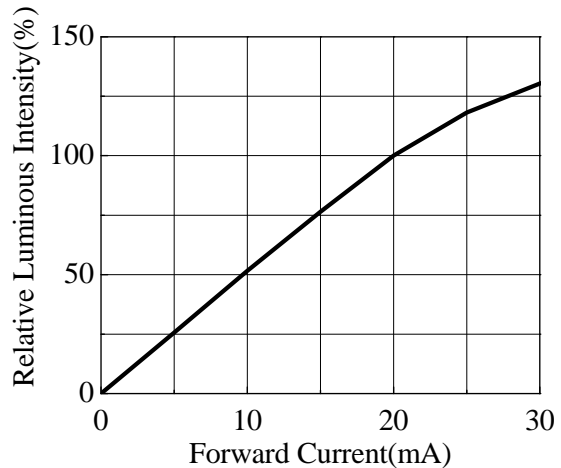

**Relative Intensity vs. Wavelength**

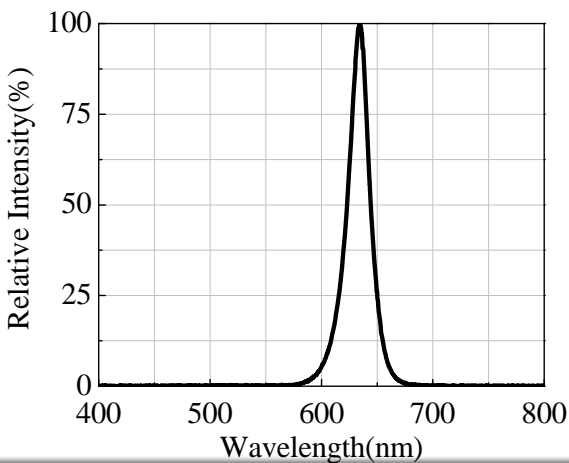

**Radiation Diagram**

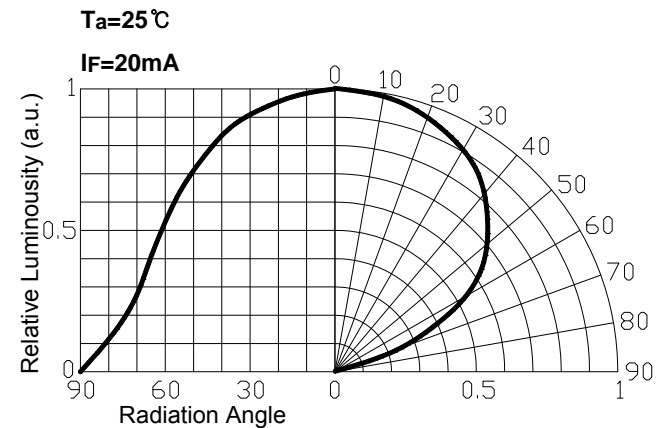

# Topview 5050 SMD LED

## IWS-L5056-RGB-K3



### 6.2 Green

**Forward Current vs. Forward Voltage**

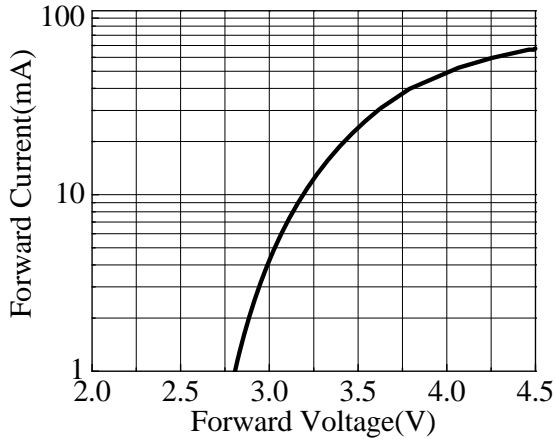

**Forward Current vs. Ambient Temperature**

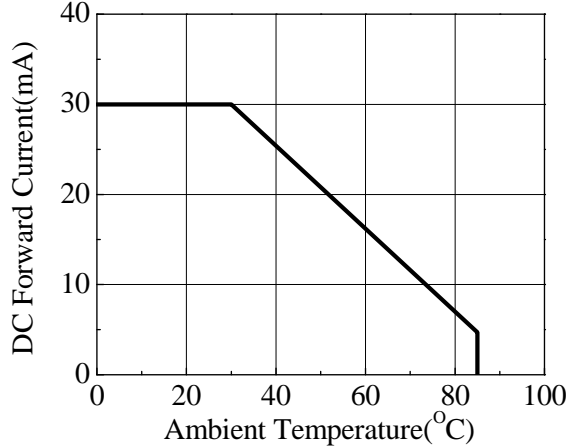

**Relative Luminous Intensity vs. Ambient Temperature**

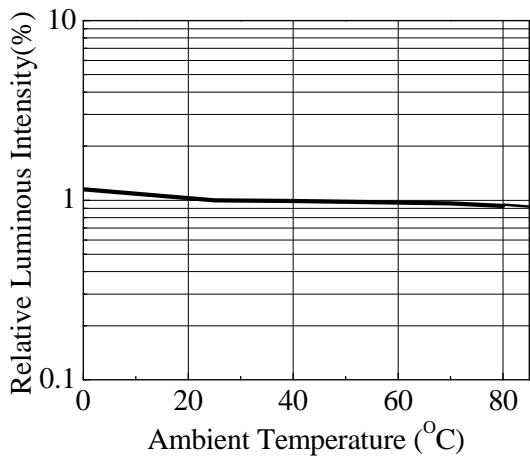

**Relative Luminous Intensity vs. Forward Current**

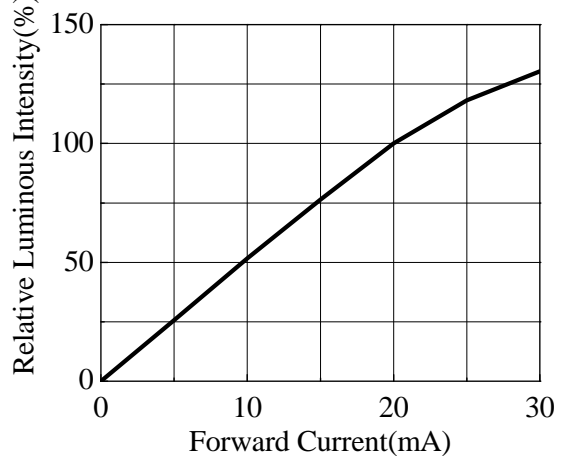

**Relative Intensity vs. Wavelength**

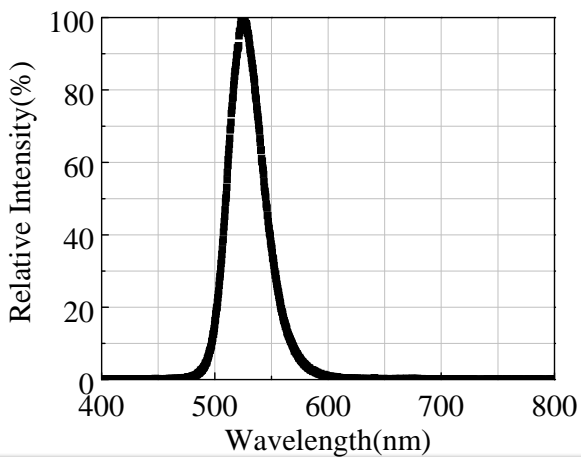

**Radiation Diagram**

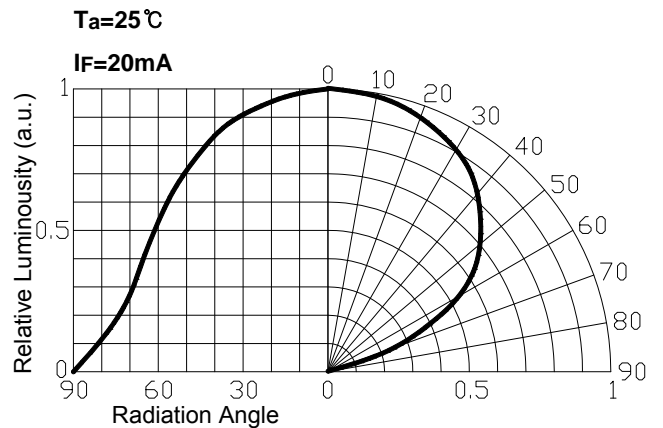

# Topview 5050 SMD LED

## IWS-L5056-RGB-K3



### 6.3 Blue

**Forward Current vs. Forward Voltage**

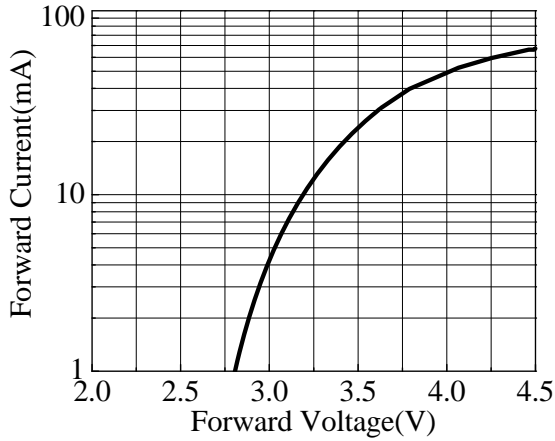

**Forward Current vs. Ambient Temperature**

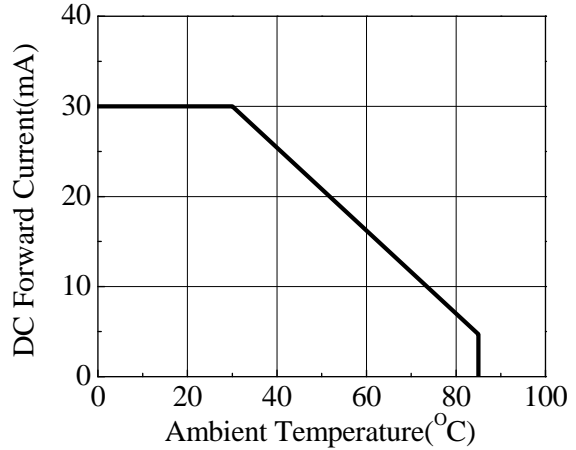

**Relative Luminous Intensity vs. Ambient Temperature**

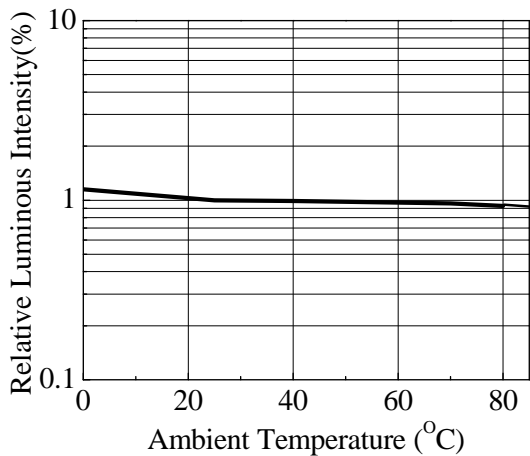

**Relative Luminous Intensity vs. Forward Current**

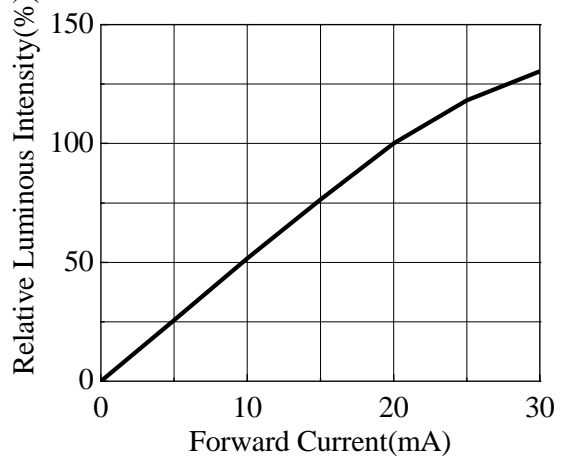

**Relative Intensity vs. Wavelength**

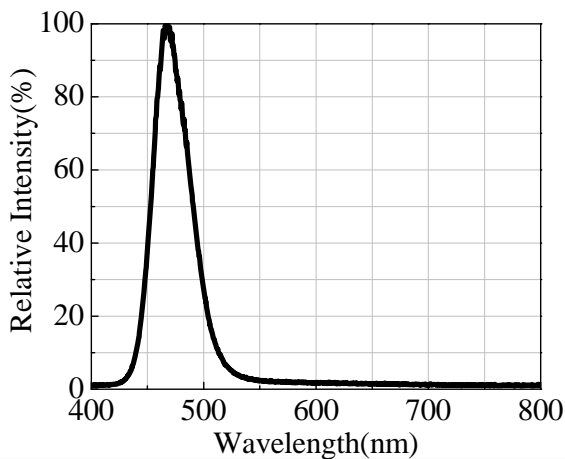

**Radiation Diagram**

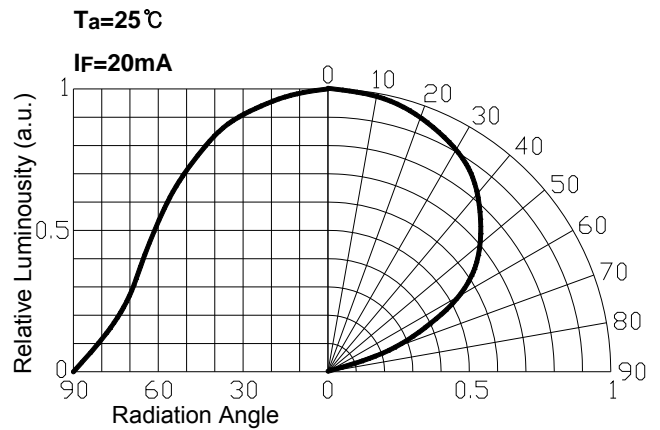

# Topview 5050 SMD LED IWS-L5056-RGB-K3



## 7. Dimension of Tape / Reel

### 7.1 Tape Dimension

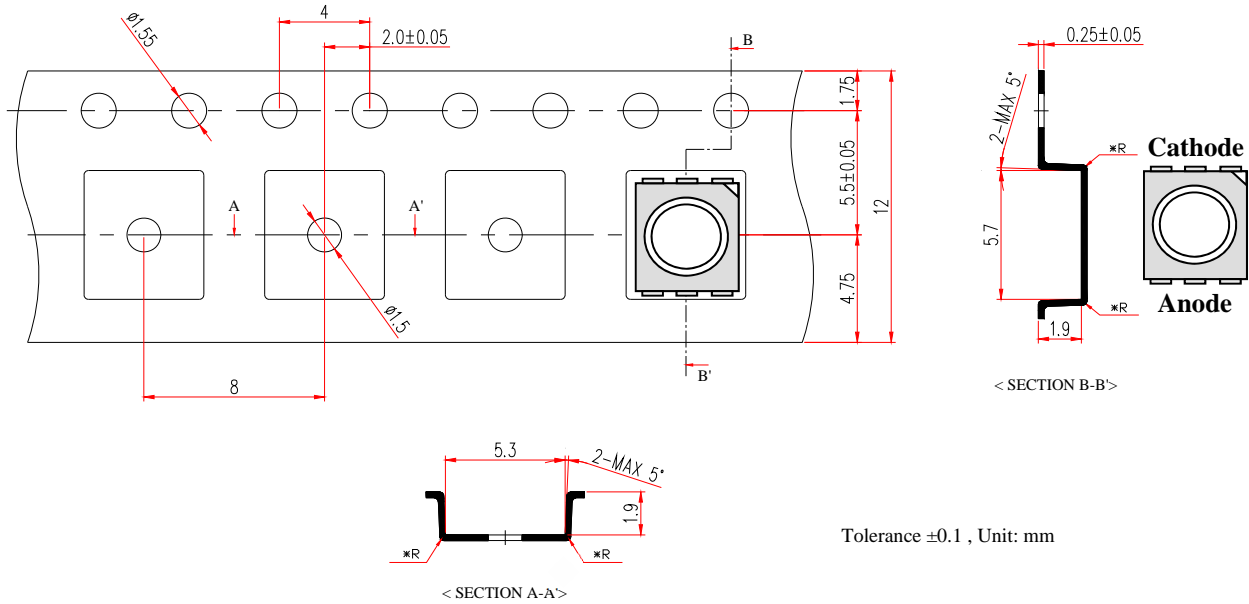

### 7.2 Reel Dimension

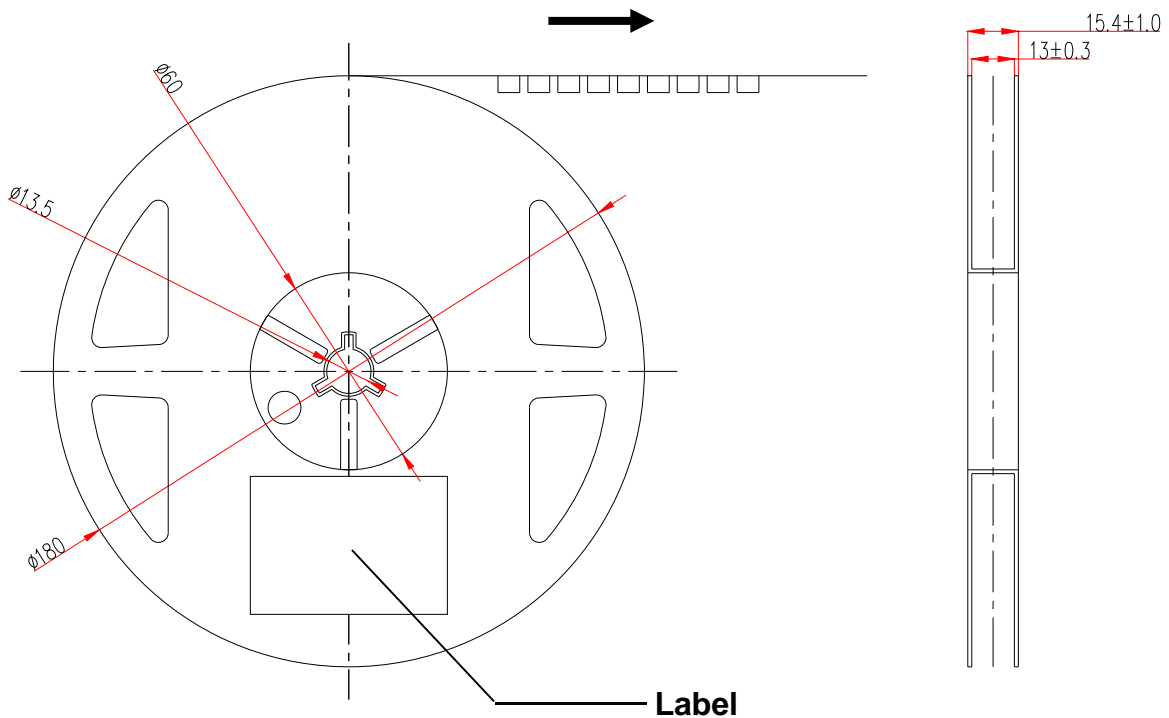



# Topview 5050 SMD LED IWS-L5056-RGB-K3



## 8. Packing Dimension

Unit :mm

**Reel**

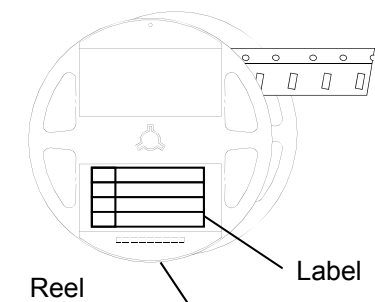

Bake: 60°C, 48hrs



**Aluminum Shield Bag**

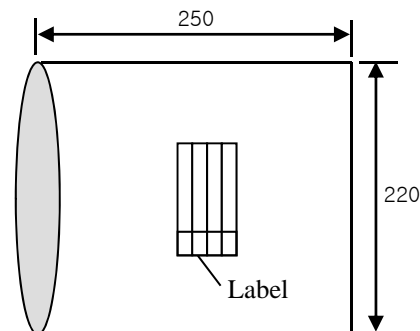

Including Silica gel in a bag



**Card board Box**

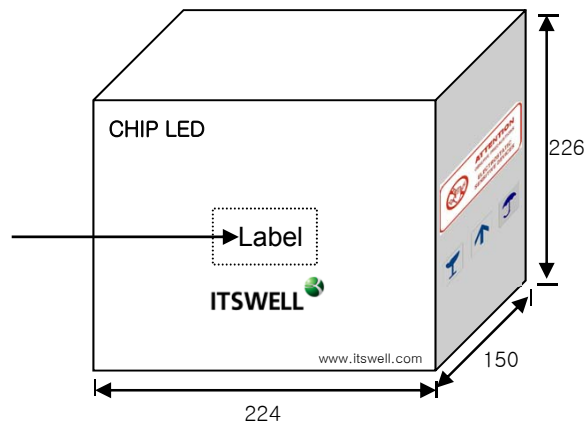

**Al Pack Label, Reel Label**

(70 × 37)

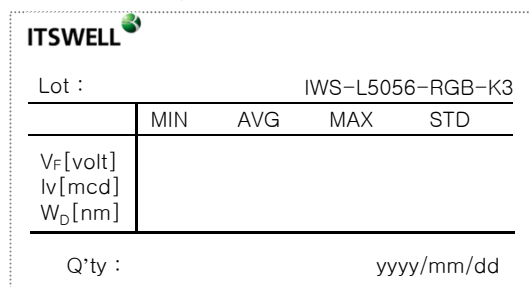

	Dimensions (mm)	Reel / Box	Q'ty / Box(pcs)
Reel	Φ180mm, 15mm Width	-	1,000 Max
Al Shield Bag	250x220	-	1,000 Max
Card board Box	224x150x226	9 Max	9,000 Max

## 9. Precaution in use

### 9.1 Soldering Conditions

- When soldering Power SMD, Heat may affect the electrical and optical characteristics of the LEDs.
- In soldering, do not stress the lead frame and the resin part under the high temperature.
- The silicone part should be protected from mechanical stress or vibration until the Power SMD return to room temperature after soldering.
- Preliminary heating to be at 160 °C max. for 120 Seconds max.
- Soldering heat to be at 260 °C max. for 5 sec. Max.
- For manual Soldering is Not more than 3 sec @MAX 350 °C, under soldering iron

#### < Lead Free >

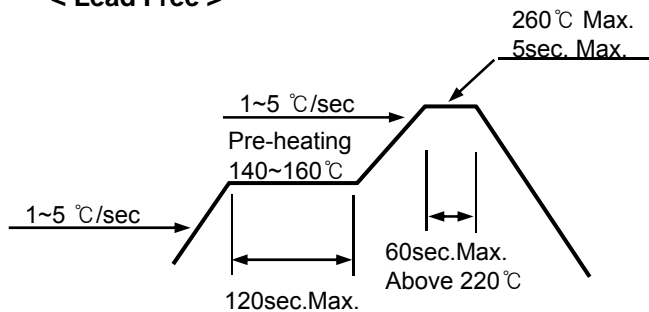

#### <Recommendable soldering pattern>

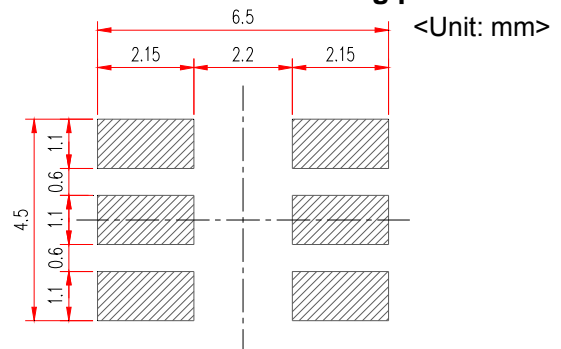

### 9.2 Storage

- Before opening the package, the LEDs should be kept at 30 °C or less and 70%RH or less.
- The LEDs should be used within a year.
- After opening the package, the LEDs should be kept at 30 °C or less and 30%RH or less.
- The LEDs should be used within 168 hours (7 day) after opening the package.
- If the moisture absorbent material (silicagel) has faded away or the LED have exceeded the storage time, baking treatment should be performed using the following conditions.  
Baking treatment: 60 °C ±5 for 48 hours.

### 9.3 Static Electricity

- Static electricity or surge voltage damages the Power SMD . It is recommended that a wrist band or an anti-electrostatic glove be used when handling the LEDs.
- A tip soldering iron is requested to be grounded. An ionizer should also be installed where risk of static.
- All devices, equipment and machinery must be properly grounded (via 1MΩ). It is recommended that measures be taken against surge voltage to the equipment that mounts the Power SMD.

### 9.4 Cleaning

- Isopropyl Alcohol or Ethylene Alcohol is recommended in 5 minutes at room temperature. Don't use unspecified chemical may cause crack or haze on the surface of the epoxy resin.
- Before cleaning, a pre-test should be done to confirm whether any damage to the LED will occur.
- Freon solvents should not be used to clean the LEDs because of worldwide regulations.

### 9.5 Heat Generation

- When the LEDs are illuminating, operating current should be decided after being considering the ambient maximum temperature.
- Please consider the heat generation of the LED when it is designed the PCB.

## 10. Reliability

### 10.1 Reliability Test Item

Test Items	Test Conditions	Notes
High Temperature Storage	100℃, 1,000hr.	0/25
Low Temperature Storage	-40℃, 1,000hr.	0/25
Temp. Humidity Storage	60℃, 90% RH, 1,000hr.	0/25
Steady State Operating life	25℃, 72mA, 1,000hr.	0/25
High Temperature Operating Life	85℃, 30mA, 1,000hr	0/25
Low Temperature Operating Life	-30℃, 60mA, 1,000hr.	0/25
Steady State Operating life Of High Humidity Heat	60℃, 90% RH, 45mA, 1,000hr.	0/25
Thermal Shock	-40℃(30min)↔100℃(30min.), 100 cycle	0/20
ESD	HBM, 100 pF, 1.5 kohm, 3 times	0/20

### 10.2 Criteria for Judging the Damage

Parameters	Test Conditions	Criteria for judgment
Forward Voltage ( $V_F$ )	$I_F = 20 \text{ mA}$ (1 Chip)	Less than 110% of U
Luminous Intensity ( $I_v$ )	$I_F = 20 \text{ mA}$ (1 Chip)	> 70% of S

\* U means the upper limit of specified characteristics, S means initial value.

# Topview 5050 SMD LED

## IWS-L5056-RGB-K3



### 11. Part Name Description

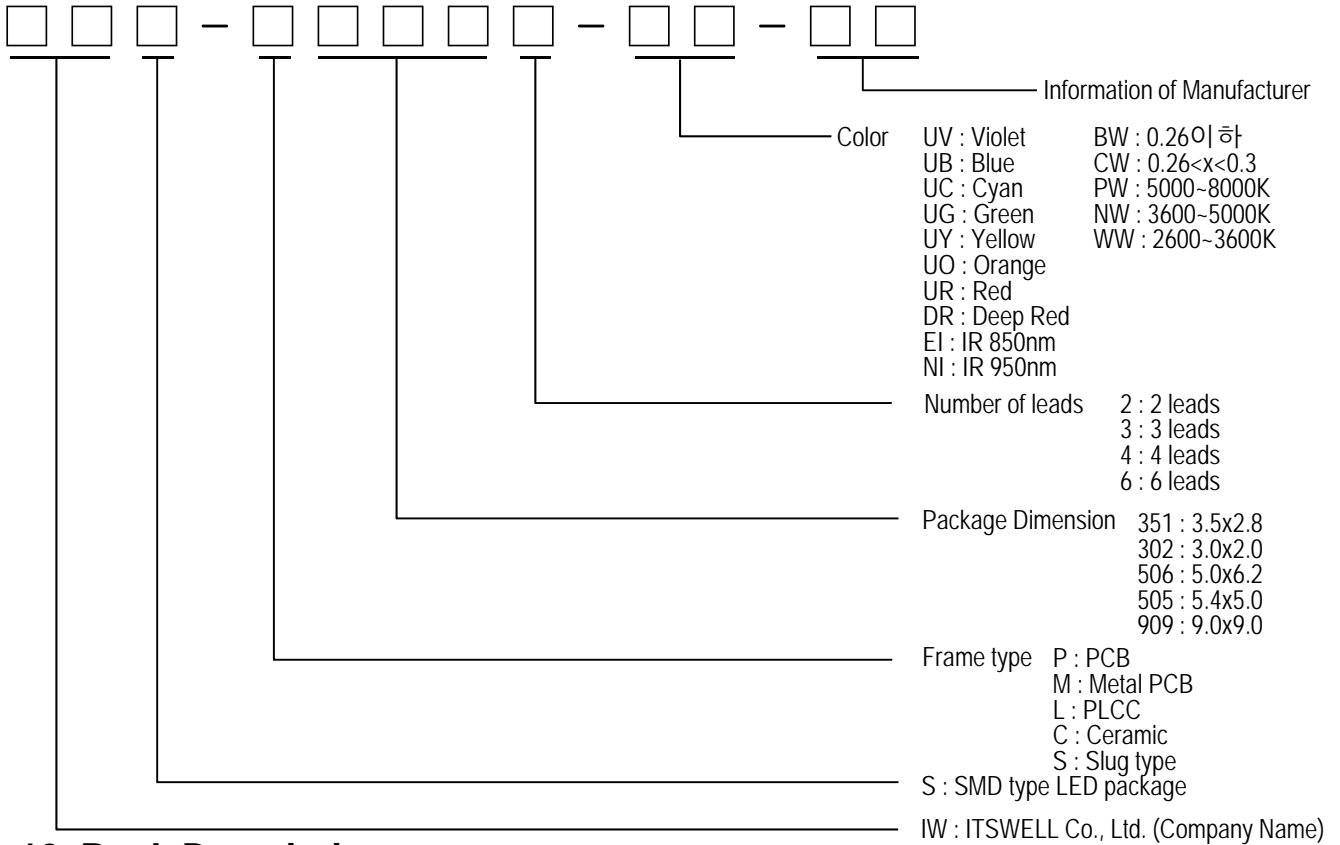

### 12. Rank Description

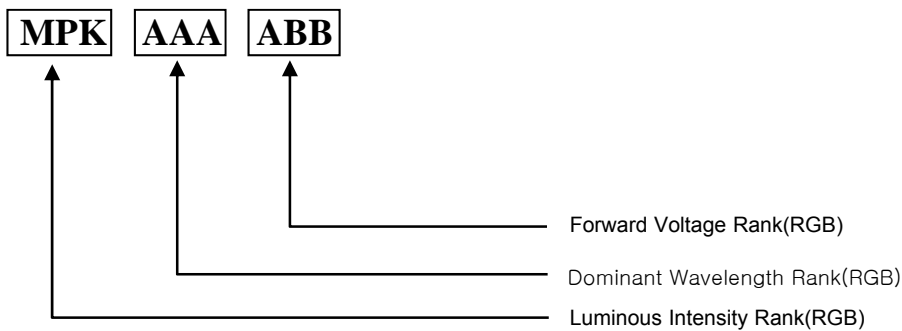

### 13. Attention : Electric Static Discharge (ESD) Protection



The symbol shown on the page herein to introduce 'Electro-Optical Characteristics'. ESD protection for GaP and AlGaAs based chips is still Necessary even though they are safe in low static-electric discharge. Material in AlInGaP, GaP, or/and InGaN based chips are STATIC SENSITIVE devices. ESD protection has to considered and taken in the initial design stage. If manual work/process is needed, please ensure the device is well protective From ESD during all the process.

